

Model radio control CARS

ISSUE No. 16

Price 60p \$1.50 (US) DM3.50 Fr. F6 Glr. 3.50 SF 3.00

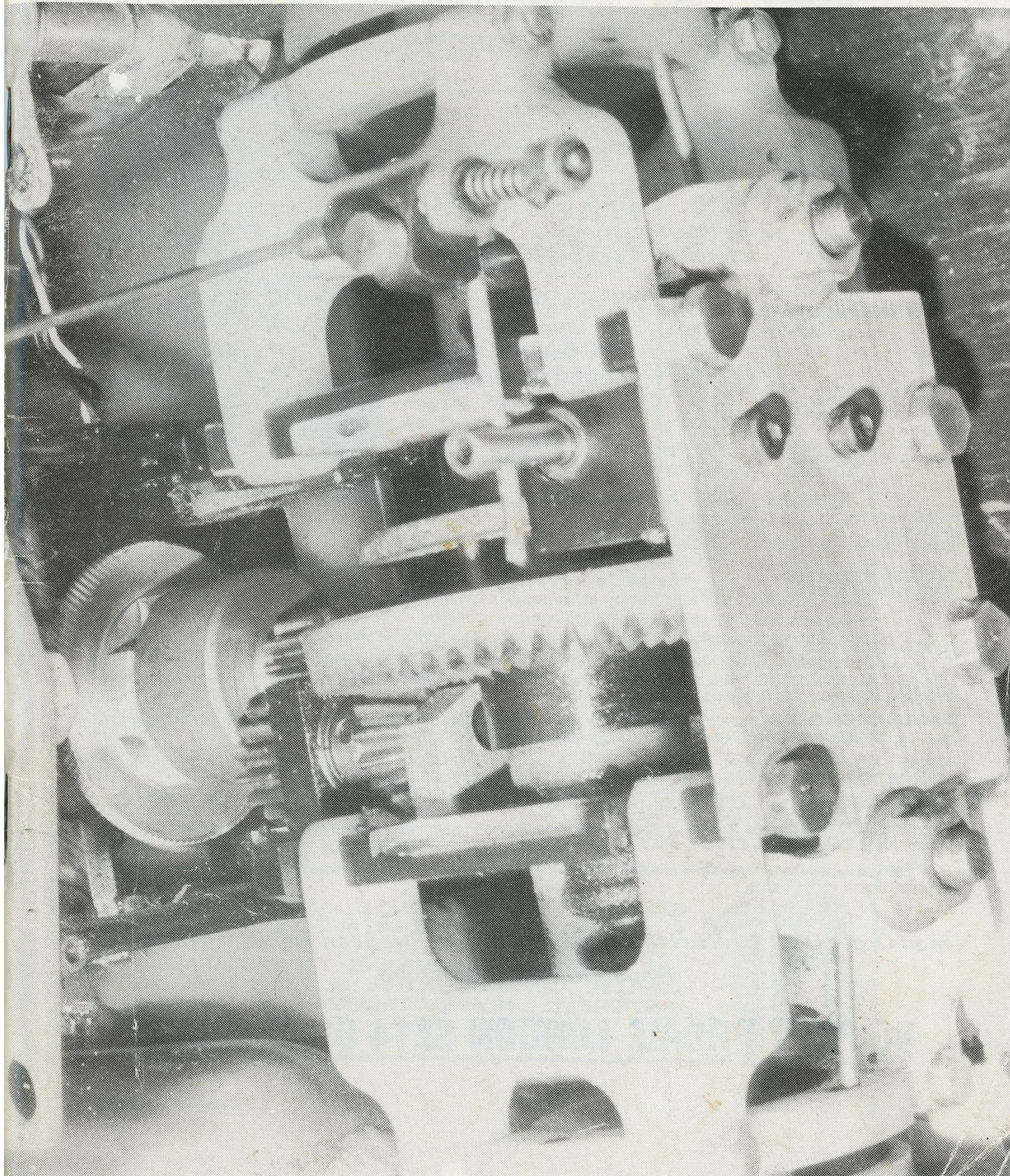

R/C CARS Ted Longshaw for Service & Experience



9 YEARS INTERNATIONAL RACING EXPERIENCE IS AVAILABLE TO HELP YOU!

JUST 'PHONE YOUR NUMBER THROUGH

FAST TURNAROUND

CAR KITS

1/12 ELECTRIC	
MARDAVE 4-Cell	£34.95
MARDAVE 6-Cell	£42.95
LECTRICAR (3 Body Styles)	£47.75
LECTRICAR STOCK CAR	£59.75
ASSOCIATED RC12E BASIC	£31.50
ASSOCIATED RC12E Complete	£59.95
S.G. ANTERES	£34.95
TAMIYA RANGE	List
TRIAL 12 BUGGY	£47.50
BOLINK	£50.00

1/8 I.C.

P.B. INTERNATIONAL

6	£79.85
7	£70.40
8	£95.30
9	£127.25
10 (Cot)	£45.95
ASSOCIATED RC100	£50.00
ASSOCIATED RC300	£87.95
SERPENT	£80.71
SERPENT COMPETITION	£126.00
MARDAVE RACING CAR	£25.30
COMPETITION STOCK CAR	£30.50
AUTOCROSS	£26.50
CHALLENGER	£88.50
SG RODEO	£35.00
SG FUTURA III	£69.95

DELTA SUPER J RANGE

SANDMASTER BUGGIES . . . £125.00

TED LONGSHAW'S CATALOGUE

Ted's NEW 1980 Catalogue!

All this and more in the latest 56-page 1980 CATALOGUE. Send for yours at once

75p



R/C MODEL CARS
Price 75p

ENGINES

VECO 19	£29.20	O.S. 21	£50.00
VECO 21	£31.85	PICCO 21	£84.50
K&B 21	£49.50	McCoy/KB 21	£62.50
OPS 21	£54.00	IRVIN 20	£30.00

1/12 & 1/8 BODIES - MOST OF THE RANGE FROM THE FOLLOWING MANUFACTURERS IS NORMALLY EX-STOCK: P.B. Products 1/8 only (ABS & Lexan); PARMA 1/8 & 1/12 (Lexan); BOLINK 1/12 (Lexan); M.R.P. 1/12 (Lexan); ASSOC. 1/12 & 1/8 (Lexan). In addition many are available ready-painted or we have paint from PARMA, GREENO OR G.B. MODELS.

RADIOS - FOR 1/8 SCALE: 2-ch Radios from FUTABA & The New JR Equipment from MacGREGOR. Plus 17M Servos, Ni-Cads, Chargers. FOR 1/12 SCALE - ACOMS, SANWA, etc.

TYRES - 1/12 & 1/8 Tyres are ex-stock in their thousands from ASSOCIATED, BOLINK, DELTA, PARMA, P.B. PRODUCTS, THORP, GREENO, MARDAVE, S.G., UFRA, SERPENT and even T.L. BETA.

Split-Time Stop Watches £17.50; Differentials from AMPS, SCHUMACHER, P.B., DELTA, S.G., SERPENT.

The PHIL BOOTH SPECIAL Range of Accessories to suit the P.B. Engine Mods. etc., from DICK McCOY. Glow Packs, Field Chargers, Ni-Checks, etc. PLUS the most comprehensive range of spares in G.B.

REMEMBER - we only deal in R/C Cars (no Boats, Planes, etc.) and we know what we're talking about. Trade supplied with most items.

Mail Order Only Address (no stock held here) European Export No Problem. Trade Enquiries Welcome.

80 PEPYS ROAD, LONDON SE14 01-639 5080

radio control MODEL CARS

Published by L-D EDITORIAL - TECHNICAL SERVICES LTD., P.O. Box 30, HEMEL HEMPSTEAD, HERTS. HP1 1NL. JULY/AUGUST 1980.

Editor: "Dickie" Laidlaw-Dickson

HOW GOOD IS YOUR CIRCUIT?

THERE has been a lot of heartburning since the publication of the official standards demanded of a circuit to receive the EFRA "good housekeeping seal of approval" if I may borrow the phrase from an esteemed contemporary for the moment. I just cannot stand the word "sanctions" which has crept into EFRA nomenclature! What in fact it is to use a more apt motor racing expression is a "permit." This goes a great deal further than just approval of the circuit and its facilities, it also includes, surely lending an official presence to the meeting and having the overall authority in case of dispute over interpretation of the rules.

I very much doubt if any circuit in Europe comes anywhere near the ideals set out in the "Sanctions Conditions." However, it is not a bad standard at which to aim; there will not be many hitting the target in the immediate future! As Ted Longshaw puts it in his April Newsletter something like £10,000 can be the total amount spent by drivers coming long distances across Europe, and even further afield, to take part and they should be confident that at the end of the journey they enjoy something worth the money and effort. I know there is always the unpriceable value of the actual meeting between the world's (or continent's) most expert drivers and the social aspects of such meetings that no code of standards can include... but let us at least know the circuit is adequate and that wives and girlfriends can be safely left to enjoy the amenities. I have been to some lovely spots that could only have earned very black marks in that direction!

Some of the more recently constructed circuits in Europe already come very much within a reasonably acceptable standard that should not set drivers and visitors

gibbering... I would instance Wiesbaden as prettily sited, with adequate direction, refreshments, ambience and a nearby town with excellent entertainment and other pleasures; the once-off Geneva meeting again fulfilled necessary needs adequately. Of older circuits in this country I would suggest Lilford Park as offering very enjoyable facilities of quite a different nature... So there is really no need for anyone to get up tight about it... our best is good enough!

WORLD CHAMPIONSHIPS 1981

Next year World Champs will again be in the news. Indianapolis is the chosen venue - what could be a more suitable venue than that - and the first week in July the time. Who goes and how he/she is selected has yet to be thrashed out. Would-be visitors and aspiring drivers would be well advised to start stuffing their piggybanks right now. No doubt group facilities in the way of a charter flight will be on offer, otherwise air fares at that time of year will be at their peak.

OFFICIAL EFRA RESULT SHEETS

I have now received the first distribution of official EFRA result sheets from Philippe Roussel who will be remembered as the Publisher along with 'Lindy' of the FBA Newsletter Belgium's contribution to our model literature, a pleasantly informative occasionally bawdy effort. It was killed I fear by the insistence on both French and Flemish appearing side by side. I remember getting lost years ago on the outskirts of Brussels in a Flamand area and struggling in vain for directions until a kindly priest arrived on the scene and we managed it in Latin... these language nationalists are sometimes a problem. A word for Philippe: wouldn't it be nice if details of cars and accessories included in result sheet?

CONTENTS : EDITORIAL . . 3 CLUB & TRACK REVIEW . . 5 JIM DAVIS'S BIG MEETING . . 10 : WOT! NO BRITISH G.P.? . . 13 : A NOVICE BUILDS A PB9 . . 17 MINICARS CHALLENGER . . 22 : TYRE CHART FOR 1/12 . . 25 JOMAC LIGHTNING 2000 . . 30 : WELSH GRAND PRIX . . 34 : DUTCH GRAND PRIX . . 38 : RSCA FIXTURE LIST . . 39 : MAIDENHEAD OPEN 80 . . 42 : SHOPPING AROUND . . 50

16

MORE IN THE MODEL CAR TRADE THAN EVER

Richard Beckett of G.B. Models of Weston-super-Mare who was the creator of the Mendip Model Car Racing Circuit asks me to correct any rumours that he was quitting the model car business. Rather the contrary, business is indeed so busy that he has disposed of his interest in the circuit to his partner Jack Keay in order to have more time to devote to his increasing circle of customers. Mr Keay on his part will be devoting his efforts to providing the finishing touches to the circuit, handling the commercial details of such an undertaking, whilst leaving the club itself to arrange meetings, organise racing and the like. A combination padlock is now fixed on the entrance and only paid-up members know the code. . .

BETTER LATE THAN NEVER . . .

This issue is late (I know a lot of you will be saying it the other way round: better never late) for which I apologise and go into clever explanations. First of all I was going for a longish trip to Canada anyway and to take advantage of the best prices by Canada Airways had to slot it in when I did. With careful timing it would have been possible in theory to have nipped in a quick one in mid May if I had really pulled out all the stops and had a willing printer. Alas, this was just the time when there was a bit of a printing dispute which was slowing things up. . . I don't think my printers were very deeply involved but it was just too much to hope to be at the head of the queue all the time so I just dumped most of the galley on them with pious hopes it would all be set by my return. . . Sorry chaps – it will probably be late again from time to time but not having a huge staff (just me) this is bound to happen.

THE BEGGING BOWL IS OUT

On much the same lines of the poor old cottage industry I have been sending round an extra letter with my begging letters – statements and invoices to you commercial people – reminding traders that if they did not pay up I would stop supplying them for free and even put in Mr Smellie the debt collector if things got really bad. . . and oh my, the abuse I have been receiving for actually asking for money! Some quite rightly reminded me that they had paid already but could not resist adding a little moral advice: “. . . if you aren't any good at keeping a true account you'd better pack up chum” or “I am not going to thank you for your impertinent little letter. . . if you are still in busi-

ness next issue you may send me . . . copies.” My invoices all say: “Please pay on invoice no statement will be sent” but it has not stopped the need for the statements alas.

Meanwhile thanks to that hard core of model traders who never need reminding and keep me from financial frenzies and carpet biting.

A WINNER OF YESTERYEAR

Two years ago we ran a competition to pick the winning order for the first Monaco World Cup with kits and other prizes donated by the model trade. No one got it quite right, but there were some near misses in the several hundred entries. I have just heard from second prize winner Doug Hull, a former Lilford Park member who won a PB7 International kit for his efforts. He is now living in Germany and I quote from his letter: “. . . I would appreciate any assistance you may be able to render with names and addresses of clubs in the Hanover area. I have tried in vain to find a local club, they all prefer 'buggies' to adrenalin packed speedsters. . . When are you going to do another competition? I would love the opportunity of possibly updating my PB7, which after many updates still runs beautifully, surely a credit to Keith Plested's fine engineering. Also the scene over here is one of SG dominance, as distributed by the Firm Robbe, with a small peppering of Associated, which makes my PB the odd-one-out if not usually ahead! . . .”

I sent along a German Racing Calendar and a Club list so hope by now he has fixed on a suitable club with the right sort of racing interests.

INTERNATIONAL GRANDPRIX MEETINGS

Already two Grand Prix Meetings have taken place – with more by the time this goes to press – first being the Spanish meeting in Valencia. This attracted Arturo Carbonell from U.S.A. but Europeans held their own with Vittoriano Orazi of Italy pipping Phil Booth for second place and chased home by Felix Galavis of Venezuela in 3rd for the Formula race. Sports/GT showed Phil Booth at his best, winning from Arturo who was close on his heels, and young Orazi a neck and neck third. Next came the Dutch G.P., when Phil Greeno returned to form (it's all those electric races with Gemini that did it!) and took the flag on both days, getting home ahead of Ronnie Ton who was in 2nd spot on both occasions.

CLUB & TRACK REVIEW

Radio Stockcar Association

Hon. Secretary: J.M. Varley
4 Bowood Drive
Sandbeds
Keighley W. Yorks.

A somewhat indignant RSCA Sec writes to correct the claim made in the report of Stock Car England Champs last issue: “The Keighley and District Model Engineering Society constructed the first purpose built track for R/C Stock Cars in 1977, and it has been in continual use since 1978, including the BRISCA Promoter sponsored RSCA World Championship in 1979. The circuit also has permanent Drivers, Rostrum, pit area, lap scoring and P/A facilities, spectator safety fence and club house.” Thanks John, appropriate sackcloth and ashes. So, we have at least two purpose built stock car circuits: what a pity it is that so few foreign drivers take part in our “world champs”!

Haywards Heath R/C Stock Car Club

Secretary: Pete Bryant
33 Quarry Road
Tunbridge Wells
Kent TN1 2EY
(Tel: Tunbridge Wells 30207)

After a quiet period the club is now under completely new management and is expanding once again. A very warm welcome is extended to any members both experienced and novice. It has always been the policy of the club to intro-

duce novice drivers gently to the sport with advice and practical assistance freely available from the more experienced drivers: So newcomers can take heart without any fear of being immediately thrown in the deep end! Meetings take place fortnightly throughout the season and there is plenty of scope to achieve success. Venue is at the club's old home in Haywards Heath with racing under RSCA rules. Membership fee is £3.00 a year and prospective members should get in touch with Sec Pete Bryant as above.

North East R/C Car Club

Secretary: J.W. Clarke
19 Oswald Terrace
Gateshead (Tel 771132)
Tyne & Wear

Club PRO Bill Gordon has done a splendid job of publicising the club and its programme with their own club calendar and attractive park grounds for their Sunday racing. A fine spread of trophies and their proud recipients has also come along showing the juniors along with their older clubmates who might well be a little shamefaced since the youngsters took first and second places in the club saloon handicap class! Altogether the club can be very satisfied with progress as members took home no less than thirty eight trophies from national class events during the 1979 season!

North East R/C Car Club winners en masse: Paul Sargeant, Pete Watson, Michael Loftus, Dave Robson, Jon Clark, Les Bailey, Brian Coombs, Jim Clark, Alan Clark, Kevin Thornton, Mark Stals, John Wilson, John Porter, Gary Bourn, John Gordon, Sam Robson, Dave Coates.



Weymouth Radio Car Racing Club

Secretary: Kevin Murray
32 Spring Avenue
Rodwell
Weymouth
Dorset DT4 8XA

This is a newly formed 1/12th scale electric car racing club with regular Monday evening meetings at "Upwey and Broadwey Memorial Hall" starting at 7.30. This will continue until October when a new venue is under negotiation. New members are very welcome. Contact the secretary and arrange to go along one racing evening.

Rotherham Electric Car Club

Secretary: Phil Maxfield
40 The Brow
Brecks (Tel: Wickersley 5055)
Rotherham S Yorks S65 3HP

Club is continuing to prosper with an active membership of fifty five. Meetings take place every Monday 7-11 pm at Montgomery Hall, Wath-upon-Deerne, Rotherham. An annual club championship in both open and handicap classes is run and twice yearly junior champion. Ambitiously the class have organised the first National Rally cross for off-road vehicles in both 1/12th and 1/10th scale, which will also have taken place before this appears. Let's wish back good weather for them! More in time will be their Rotherham Scale-down meeting on the weekend of 4th/5th October with an entry limit of ninety six Modified class will be run on the Saturday and standard class on the Sunday.

Frome Electric Car Club

Secretary: D. Chedgy
1 Church Street (Tel: Frome 2139)
Frome
Somerset

The club is now well into its second year of racing, with over thirty racing members with room for still more to join. Club membership for seniors is £2.50 a year, with Junior rate only £1.50. The Indoor Champs. resulted in a win for Sec Chedgy driving a modified Spectron, M. Jay 2nd with a modified Associated and M. Cooper 3rd also with an Associated. All six top drivers were using Smoothtronics and Schumacher diffs (Commercial? No just satisfied customers). During the winter all weather champs were held rain or snow first three cars all being Associated in hands of N. Rogers, M. Cooper and M. Jay. Summer outdoor champs about to start for standard or modified cars. New members welcome - apply sec.

Sussex Adders 1/12 R/C Electric Car Club

Secretary: Gerry Hooper
12 Bramble Crescent
Durrington
Worthing (Tel: Worthing 62013)
West Sussex

New secretary reports continuing progress of the Sussex Adders. Regular meetings still at Eastergate Parish Hall, Barnham Road, Eastergate (just off A9 near Bognor) Friday nights 8-11 p.m. plus two Sunday afternoons a month if hall is free. In conjunction with Lancing Electric Car Club a Sussex Drivers' Championship (for resident and club members) is being organised and will by now have taken place. Later in the season it is hoped to organise an Open Meeting - something like this by the seaside should appeal to all members of the family!

Nene Radio Car Club

Secretary: Colin Spinner
52 St Johns Avenue
Northampton (Tel: 604 844943)
NN2 8RU

Grand Prix 80 is to be high spot of the club's year though alas will be over by the time this appears. Nice touch is that radio licence and proof of insurance will be required of the hundred entries. Apart from the BRCA racing additional events will include (or have included!) a solo motorcycle race (limited to 30 entries); and a Motorcycle and sidecar event if Tamiya supplies come through in time though scratch entries welcome. A Tamiya Formula 2 race should also be popular with entrants retaining the standard 380 motor and five cell 6-volt motor.

For future thoughts there is an adjacent swimming pool. Normal club racing takes place Friday nights from 7.30 at Christchurch Hall, Christchurch Road, Northampton. A regular 35/40 members race on a smallish but grippy track. New members and guests always welcome: contact Colin.

Sussex Radio Auto Club

Secretary: Dave Heighes
310 Portland Road
(Tel: Brighton 419279)
Hove, Sussex

Stock car racing is stronger than ever in the south with the Sussex R.A.C. reporting over twenty active members, mainly stockers with a few Sports/GT on the way. Meetings are held every other Sunday afternoon at the Cardinal Newman School, Upper Drive Hove with a monthly get-together at the Golden Cross Hotel, Portland Road Hove with a pint and a chat,

(More on page 47)



Gemini

COMPETITION 1/12 SCALE R.C. CAR
DESIGNED BY PHIL GREENO

Winner of both Saloon and Sports Car Events at British Winter Nationals Exeter 1980

FEATURES

- GRP Countersunk Chassis
- GPR Radio Plate
- Lightweight machined alu. axle blocks with adjustable motor mounts
- Ball-raced Rear Axle
- Schumacher Differential with Quick Release Wheels

- Lightweight Front Suspension with Ackerman steering
- Lexan Body and Adjustable Wing Wire Set
- 6-cell Ni-Cad Pack and Charge Leads
- Race proven Winning Success

- Adjustable Body mounts front and rear
- Available with Indoor or Outdoor Tyres
- Very high construction quality for reliability
- Designed to fit BRCA ROAR and EFRA Rules

KIT PRICES

PGE 1201 BASIC ROLLING CHASSIS Kit only, contains all hardware but no Ni-Cads, motor, body, charge leads, etc.

£49.95

PGE 1202 COMPLETE KIT includes motor, Ni-Cads, charge leads, Lexan body, and wing, Suspension parts, body mountings

£75.00

PGE 1203 "COMPETITION SPECIAL" as above but comes ready built, includes lightweight comp. chassis, painted Lexan body and wing wire set, Parma Renault 05 motor (BRCA, ROAR legal)

£85.00

"ADAMS DEMON" SPEED CONTROLLER

Electronic Speed Controller with fully proportional forward speed and dynamic braking. Plugs into Receiver, regulated 5-volt supply eliminates Rx battery and throttle servo. Very high construction quality. Proven reliability

Available in two versions

PGE-DM1 Proportional forward with dynamic brakes

£34.50

PGE-DM2 Proportional forward with dynamic brakes and reverse

£39.95

ALL PRICES INCLUDE VAT

EXPORT AND TRADE

ENQUIRIES WELCOME

AVAILABLE AT ALL

LEADING MODEL SHOPS

ACCESS - BARCLAYCARD - HOBBYCARD
PLUS FAST MAIL ORDER

Manufactured and Distributed by

 PHIL GREENO MODELS LIMITED

9 VILLAGE WAY EAST, RAYNERS LANE,
HARROW, MIDDX. HA2 7LX. TEL. 01-866-7770

RADIO CONTROL SPECIALIST AND SERVICE ENGINEERS
Planes • Boats Run by Modellers – for Modellers



HOBBIES CENTRE LTD.
Tel. 0742-581197
148 London Road, Sheffield 2

Helicopters • Cars

Hours 9.30—5.30 Closed all day Thursday

Large stock of Radio Control Outfits, most popular makes now down in price!

NEW
Futaba 2L plus 2 Servos (Dry) **£44.00**
Futaba 2L with FD17M Servos **£58.00**
REDUCED
Sanwa Stack 2 plus 2 Servos (Dry) **£38.75**
S.H.C. Ni-Cads and Charger for above **£24.80**
MacGregor Digimac 2 plus 2 Servos (Dry)

Now Only **£45.00**

MacGregor Digimac 2 Special Car Outfit with 2 Fast Servos, Ni-Cads and Charger

Now Only **£89.00**

NEW
MacGregor JR Series FM-2, all Ni-Cad with 2-High Torque Servos **£115.00**

1/8 SCALE CAR KITS

PB9 International (Inc. Diff and BodysHELLs) **£127.27**
PB8 International (Inc. Diff) **£95.30**
PB7 International (Basic Kit) **£70.40**
PB6 International (2 BodysHELLs) **£79.80**

NEW
PB10 (Beginner's Kit) **£45.00**
Mardave Competition Kit, Ferrari or Capri (F/G Chassis, new Clutch) **£29.80**
Mardave Stock-Car **£26.50**
Mardave Autocross **£26.50**
Serpent Mk II (F/Glass Chassis) **£80.70**

1/12 SCALE (ELECTRIC) CAR KITS

Mardave Mk II (6 Cell) Kit — Lola 294 Sports or Saudi Williams **£42.95**
Lectricar — McLaren, BMW or Porsche **£49.98**
Associated 12E (Inc. Motor, Ni-Cads, and Body) **£59.95**
Associated 12E Basic Kit **£29.95**
Cambria (Front Wheel Drive) — Saab or Lamb Countach **£36.95** (Ni-Cads **£16.00**)

NEW
Lectricar — Stock-Car

ACCESSORIES 1/12 SCALE

Schumacher Diffs (Mardave, Lectricar, Assoc.) **£6.90**
Lectricar Motors (with Caps and Leads) **£4.79**
Lectricar Seven Speed Controller **£5.44**
Fast/Charge Lead: (State No. of Cells) **£3.42**
S.H.C. 'One Shot' Automatic 12v Fast/Charger for 6-cell packs **£17.50**

Full range of Mardave, Lectricar, Cambria Spares, Tyres, BodysHELLs, etc.

CAR ENGINES

OPS 21 (Inc. Carhead and Carb) **£54.00**
K and B 21 (Stand. No Carb) **£39.95**
OS 21FSR (ABC) **£51.80**
Picco 21 (Stand. or Long Crankshaft) **£84.95**
Irvine 20 (Inc. Silencer) **£41.95**
Veco 21 **£31.75**
Veco 19 **£27.95**

Full Range Spares for all Motors

ACCESSORIES (1/8 SCALE)

Full range of PB International spares, send for Catalogue and Price List **30p** (Inc. Post)
PB Slide Carb. Inc. Airfilter **£27.50**
Dave Preston Slide Carb **£31.90**
OPS Slide Carb **£16.95**
OPS Slide Carb, Air Filter **£1.50**
PB Differential **£36.21**
AMPS Mini-Diff. for PB Serpent, etc. **£35.59**
AMPS Monaco Diff. for PB Int. **£57.50**
AMPS Mini-Pipe (OPS or K and B) **£13.90**
Greeno Tuned Pipe **£16.95**
Greeno New GRP Narrow Chassis **£8.50**
Greeno New Power Pod **£10.95**
Greeno New Wide Radio Plate **£6.95**
High Speed Main Bearing, OPS, K and B, etc. **£8.54**
Sullivan Starter (with Car Rubber) **£29.64**

NEW

S.H.C. "TR 500", Charger — Automatic 12v — Radio Ni-Cads Fast-Charger — T.B.A.

Full Range Tyres always in Stock

UFFRA Special, Slix and Super, Associated 2402, Do-Nuts, Serpent Hi-Bites, etc.

Full Range of Lexan and ABS BodysHELLs by PB, Parma, etc.

Greeno Lexan Paint **£1.00**
S.H.C. Porta-Power — Rechargeable 2v Starter Battery with Ameter — suitable for all Glow-Plugs up to OPS 300 **£16.50**
S.H.C. Autoglow, 12v — 2v Reducer **£14.84**

FAST MAIL-ORDER. NO DEPOSIT CREDIT (FROM £65). ACCESS, BARCLAY-CARD, HOBBYCARD JUST PHONE IN YOUR No. FOR IMMEDIATE RETURN OF GOODS

PONTIN'S
proudly present their fourth
National Model Makers FESTIVAL
— incorporating —

'The Golden Age of Steam'

'THE WORLD'S BIGGEST RESIDENTIAL FESTIVAL FOR MODEL ENTHUSIASTS' at BreaN Sands Holiday Village, Burnham-on-Sea.

TWO action-packed weeks for modellers and their families to fly, run, shunt, show or build their own models. Special courses for children and beginners, plus a whole range of interesting activities for the ladies.

Model Aircraft all types — R/C — Power — Free Flight — Slope Soaring — Combat — Gliders — Helicopters — Building — Instruction ● Fibre Glass Moulding ● Live Steam Loco's — On Site Tracks — Off Site Track Visits ● Fair-ground Models — Traction Engines — Model Engineer Workshop — Boiler Making — Welding — Brazing — Turning — Repair & Building Workshop ● Model Cars — R/C — Stock-cars — Electric — R.T.P. ● Model Scale Boats — Regattas — Straight Runners — Power Boats — Static Models — Yachting ● Military Modelling & Wargaming ● Special Optional Excursions to Steam Preservation Sites & Museums — Talks — Film Shows ● Lectures by Leading Specialists in every field

● Special Ladies Craft Section offering Instruction on a variety of Useful Crafts — Toy Making — Macramé — Confectionery — Brass Rubbing, etc. ● Pastimes for Children of all ages.

All this plus dancing and cabaret every evening and all the usual Pontin Sporting and entertainment facilities: bars, games' rooms, supermarket, day nursery, heated indoor pool, etc.

A marvellous opportunity for modellers and their families to have a really economical holiday with like-minded enthusiasts from all over the country.

Tariff per week: Self-catering chalet with colour TV, private bathroom and toilet — up to 3 persons **£53.00 + VAT.** Each additional person — **£7.00 + VAT.**

BreaN Down (027 875) 203.

Saturday 27 September — Saturday, 4 October and/or Saturday 4 October — Saturday 11 October 1980.

PONTIN'S Holiday Village, BreaN Sands, Burnham-on-Sea, Somerset TA8 2RJ.

Please send me details of the National Model Makers Festival.

Name

Address

.....

.....

.....

..... Post Code.....

MC2



JIM DAVIS' BIG MEETING

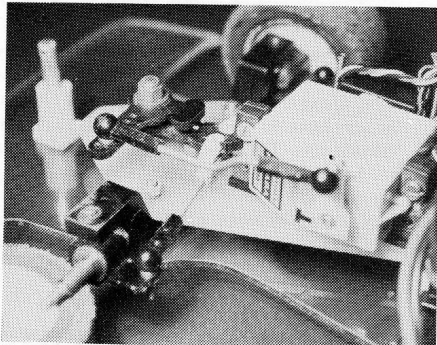

Kev Leatherland car. Note novel feature — servo raised off chassis on small plate retained by front axle beam.

Computer read out to keep drivers informed in the pits.

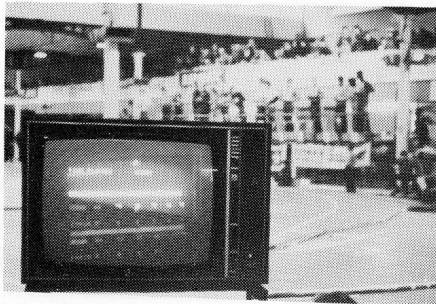

LES PIPE REPORTS:

Pit area and part of circuit. Plenty of room for even mammoth crowd. Note computer readout in centre.

1/12th scale model car racing was finally brought to the people of the Midlands in a big way! Birmingham was the venue for a spectacular programme organised by the Midland Modellers Association in conjunction with Jim Davis Models. I think it is only fair to say that this was the biggest, most ambitious gamble taken by any promoter so far. The location was Bingley Hall in Central Birmingham. This is an exceptionally large building. To fill it required some diversification, including several trade stands of model equipment, full sized custom cars, modelling exhibitions, a model steam train, clothing stalls and an interesting stand for the ladies selling oriental clothing (could have done without that, Jim, my wife spent a fortune!). Refreshment facilities were excellent. Jim even hired an adjoining hall for people to park their caravans in... a novel experience for many, I'm sure! A disco was provided after racing on the Saturday night for those still capable of keeping awake. Rumour has it that there were additional competitions going on into the early hours of Sunday morning... I'll leave that to the imagination!

The most disappointing aspect of the whole weekend was the floor. A lot of

work had been done to try and smooth out the surface, but it was still very bumpy and extremely dusty. The dust could be seen to rise as the racing got under way, only to fall again at the completion of the race. The bumps were equally destructive as daylight could be seen below the flying cars. However, all was not as gloomy as it appeared because this unenviable surface proved to be a very good leveller of driving capabilities. Previously unheard-of names came to the fore, giving hope to the 'rabbits'. Meanwhile the 'lions' were skating through their multitudes of tyres, trying to find some combination that would grip, and motors and gears that would not

earlier in the day, the first standard heats would have been very boring. Another interesting point was that several contestants reaching the modified motor final, were in fact, running their standard motors, and were competing with modified motors!

The format of the meeting was well scheduled, with Saturday seeing the qualifying heats for the Standard class, the Modified Class, the Tamiya Class and the Motor Bike Heats. With a very large entry of 200 plus, the races had to be well organised. There was a hectic scramble at the end of the day to see whether people had qualified or not. There were a few mix-ups

Tamiya combination seen in the hands of Colin Spinner at Bingley — quite sensational on or off road.

Charging: beginning to get more sophisticated — with motor limits only the utmost from the nicads is good enough!



put them into orbit. After the early heats (when the dust was beginning to disperse), the laps started to come. 13 laps were soon put up, followed by 14 and closing on 15. The pace hotted up as the day drew on. Neal Francis made the early running (as we've come to expect of the British Champion), hotly pursued by Phil Greeno driving in his usual disciplined groove. In complete contrast was the flamboyant driving of Walt Bailey with his superbly turned out works Associated. The latter was a very light car and on the circuit this lack of weight became apparent in the tuned motor class when Walt's car almost seemed to be pulling 'wheelies'. (We all know it was the bumps really, Walt!) The speeds being achieved by these battery powered whizz boxes had to be seen to be believed. The argument that the sport will be killed with the introduction of tuned motors did not go far this weekend.

The extra performance of cars entering the modified class, made it an enjoyable race for the drivers and spectators. The track was more suited for the modified motor class, being approx. 120yds in length and adequate width for 12 cars. Had there not been a problem with grip

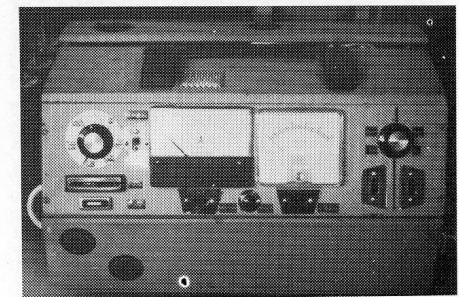

Underside view of the new Gemini — now sporting holes.

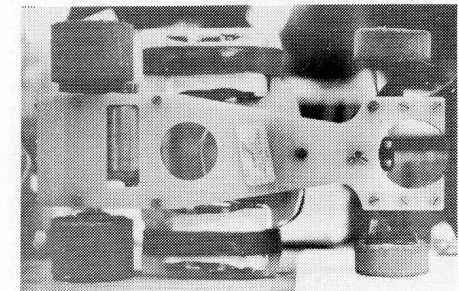

over this, largely caused by people hurrying the organisers for results, and the newly adopted handicap system. These were sorted out eventually and most people seemed happy with the results. Sunday was devoted to the quarter-finals, semi-finals and finals of the above classes.

These all proved to be interesting and exciting, with everyone putting in 101% effort to do well. As in every sport there were the triumphant winners and 'not-so happy' losers. Unlike a lot of sports, 1/12th scale racing still has a super atmosphere amongst the competitors, with the losers congratulating the winners. Long may this be!!! (See List for final results).

One idea used by the organisers of the meeting which was popular with the competitors was that of marshalling. The local A.T.C. boys were on duty all weekend doing the marshalling. This relieved the drivers of this chore, and helped the organisers. It was lovely not to hear the constant plea for marshals, which is usually heard at every meeting. There were complaints that the marshals were rather slow at times, but someone will always moan! Which do you prefer? The motor bike race proved to be a big hit with the spectators (as at Exeter).

The various tyres tried by the motor bike lads were fairly intriguing. Some had made up soft Armaflex (siliconed, of course) which in the face of it should have been devastating on this surface, but proved to be hopeless. Many resorted to standard siliconed tyres. Consistency, rather than speed, seemed to be the order of the day. Many of the drivers found this very difficult. It did prove to be a 'show stopper'.

The Tamiya race also proved entertaining for the public, and enlightening for the drivers. Neal Francis turned up a 13 lapper with his standard Competition Tamiya Toyota, which at that time was the same sort of score being put up by the racers. This was a real eye-opener which caused quite a stir in the pits. The scoring for this event was done on a cumulative total basis, and consistency again proved the stumbling block for most drivers. The 'out of the box' Competition Specials were most in evidence and proved very fast on the straight and one or two of their drivers managed to get them round the bend comfortably. My Lamba was definitely not interested in going round the bends in a civilised manner (although it probably had a lot to do with the driver). The public seemed to identify themselves with these cars much more than with our Can-Am

bodied racers, so it again proved to be a worthwhile spectator attraction, which may increase our racing band eventually.

After the excitement of the finals, it was time for the Team Endurance Race.

The crowd really got behind their favourite teams . . . marvellous vocal participation! The event was run in three parts. As 24 teams were taking part, two 12-car qualifiers were needed to arrive at the 12 car final.

The duration of the qualifiers was one hour, the final one and a half hours. The first qualifier was furiously contended between Teams Ripmax, Hobby Spot, and Spectron. There was never more than a few laps in it from beginning to end. The second qualifier was equally exciting being closely contested by the Ally Pally Team (considerably strengthened by the presence of Phil Greeno) and the Jim Davis Models Team. It was interesting to note that at the end of this qualifying heat the winning team, Ally Pally, were 20 laps up on the winners of the first qualifying round, Team Ripmax. The challenge for the final was out. Ally Pally, having given a superb display in the qualifiers were determined to do it again in the final. One or two other teams had the same idea but unfortunately were unlucky. Ally Pally (complete with broad grins) had repeated their performance.

It would be impossible to thank all the organisers of such a big meeting individually, but I think a special thankyou to Jim Davis for taking the gamble of putting on such a spectacular meeting. I'm sure we don't realise half the work that was involved in putting on a meeting of this size. Two more people who should be mentioned are Pete and Taff, who took on the job of running the actual race meeting. I'm sure it was a much bigger task than they had anticipated, and caused them lots of sleepless nights. Everyone who attended the meeting, would like to thank you both for your hard work.

Finally, I know a lot of fellow racers enjoy these National meetings because of the friendly atmosphere we come to expect. It is super to meet up with other people who share the same interests (and problems!). Because of the widespread interests of the sport, National meetings are an opportunity to get together and meet old friends and make new ones.

N.B. A great mathematical calculation which may be of interest (by kind courtesy of Pete Hales (one of main organisers)). Over the whole weekend 24,000 laps were covered . . . or 1,600 miles!

STANDARD FINAL (run over 6mins).

1. Phil Greeno. 18.373.3.
2. Bill Maisey. 18.374.5.
3. Nick Adams. 18.376.2.
4. S. Waterhouse. 17.365.7
5. D. Tongue. 17.371.8
6. K. Leatherland. 17.377.1

CONCOURS. INDIVIDUAL.

1. Colin Spinner.

CONCOURS TEAM

1. Team Chesterfield.

TAMIYA EVENT.

1. Neal Francis.

MOTORBIKE EVENT.

1. B. Stamy.

MODIFIED FINAL (run over 6mins).

1. Walt Bailey. 18.363.3.
2. Bill Maisey. 18.367.8.
3. Neal Francis. 18.370.5.
4. Colin Englefield. 18.372.1.
5. D. Tongue. 18.374.9.
6. P. Greeno. 18.376.4.

TEAM ENDURANCE RACE

1. Ally Pally. 247 laps (over 1½ hrs).
2. Jim Davis Models. 244 laps.
3. Team Mar-dave. 236 laps.

HANDICAP FINALS

- | | |
|----------------|------------------|
| 0-15 handicap. | 15-30 handicap. |
| 1. T. Wells. | 1. R. Morrison. |
| 2. B. Poxon. | 2. P. Clarke. |
| 3. C. Forster. | 3. T. Henderson. |

WOT! NO BRITISH G.P.?

Ted Longshaw's EFRA Notes for May contains the following brief paragraph: "I understand from the BRCA that difficulties regarding the circuit and administration of the event mean that the G.B. G.P. planned for July 5th & 6th had to be cancelled. The other circuits available are either booked for other events or do not have time to prepare for an important race. This is very late notification indeed and will no doubt be on the agenda of the next A.G.M. but for now it would seem there is very little EFRA can do except accept the situation."

This is frankly a very bowdlerised statement of the facts and since I have felt free to comment on the shortcomings of at least one overseas meeting I cannot remain silent on an astonishing state of affairs in our own camp! Tibshelf applied for the meeting and won the vote against the only other contender for the meeting Lilford Park by the vote of members . . . promises promises as usual as to the quality of management etc., plus assurances that the only thing that marred the recent successful Nationals held there some r/c interference would be eradicated. The club it will be remembered is one where the local authority went to great lengths to provide facilities and is indeed responsible for the ground as a notice displayed there indicates. We have looked on the committee as an ideal example of how to deal with a local authority . . . who in turn would naturally expect some local benefit from open invitation meetings for local sponsoring firms and local businesses.

I have received no notification from the club that the meeting has been cancelled, neither as editor of this magazine, nor as

Publications Officer of BRCA responsible for making a matter of this kind known, my only indication being in the EFRA Newsletter which has a very limited circulation. Seeking more news, I am told that it all goes back to a Tibshelf team event when final placings were in dispute. Unfortunately Tibshelf claimed to be the winners with others following 2nd and 3rd. After lengthy discussion Nos. 2 & 3 put their trophies back on the table saying they did not want them under the circumstances: very sportingly Tibshelf then put theirs back ditto and said now come and get them in the order you think it was! This was done with the home club now taking third. Splendid so far: but the scoring-/timekeeper unit now took umbrage and said it was a reflection on them and they wouldn't score again. A club meeting followed and it was decided that for the rest of the current season only full members of the Tibshelf Club would be allowed to race on the club circuit.

This is the "administration trouble" mentioned in Ted's Newsletter! Hospitality is a matter of being given and being received. Our drivers attend meetings overseas, and many continental drivers in the past have come over here. I wonder how welcome our drivers will be in the future? Hasn't a petty club squabble jeopardised our future good relations with our European friends? It all seems rather like our childhood days when the boy with the ball fell out with his friends and took his ball home. Naturally I shall be happy to give space for the club to explain their point of view – but it won't make a Grand Prix!

THE LATEST IN RACING TECHNOLOGY
THE ALL NEW

LIGHTNING 2000

EXPERT CLASS
1/12 SCALE
ELECTRIC RACING
CARS

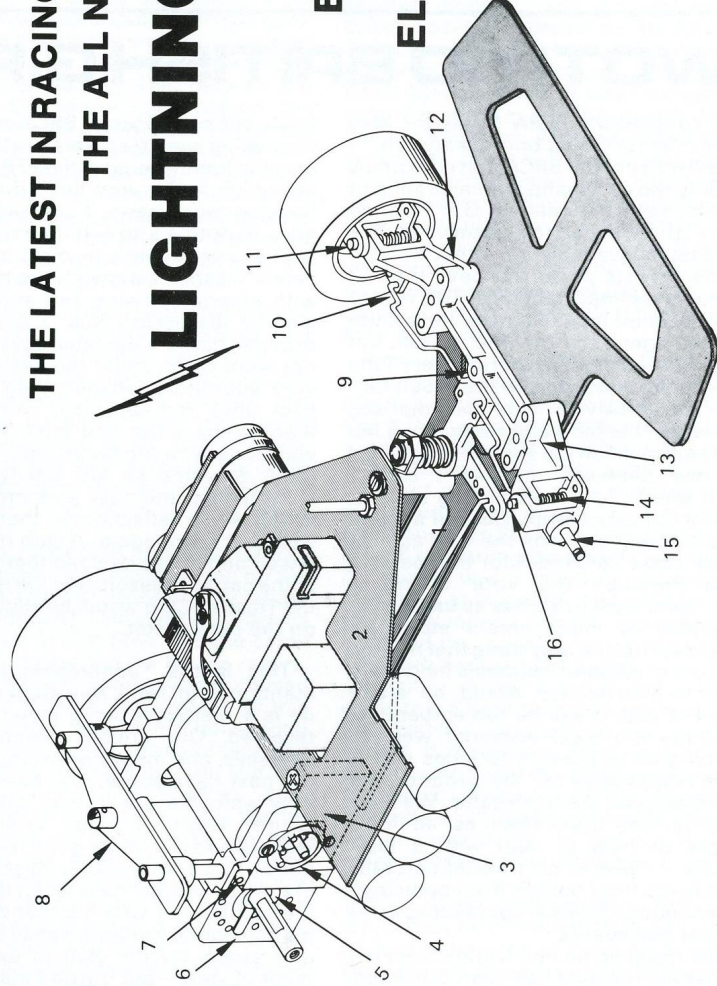

Features Quality And Adjustability Unmatched By Any Other Electric Race Car

FEATURES:

1 CHASSIS - .080 thick epoxy board

- * Pre-lightened — controlled flex
- * Routed edges (not stressed from stamping)
- * Drilled & countersunk

2 SHAKER PLATE - .060 thick epoxy board

- * Pre-cut for small servos, adapts easily to others
- * Routed edges
- * Pre-drilled
- * Accepts most receivers with no modification
- * Neat wiring

REAR POD ASSEMBLY

- 3 * Two piece light weight injection molded nylon
- 4 * Adjustable motor cam for proper gear mesh
- 5 * Replaceable oilite bearing (Ball bearing available)
- 6 * Adjustable center of gravity rear axle cams
- 7 * Adjustable wing tube/rear body mount
- 8 * Wing tube tie bar for added strength

FRONT END ASSEMBLY

- 9 * Adjustable camber
- 10 * Adjustable Ackerman steering
- 11 * Offset kingpin inside wheel on wide wheels
- 12 * Adjustable caster with shims
- 13 * One piece molded nylon crossbar for proper alignment
- 14 * Adjustable independent front suspension
- 15 * Front axles are molded into spindle
- 16 * Replaceable steel kingpins

FRONT WHEELS - MOLDED

- * Super light weight
- * Replaceable oilites
- * .900" wide
- * "A" compound medium traction sheet foam tires glued & trued
- * Full 1.4" legal diameter

REAR WHEELS — MOLDED

- * Super light weight
- * Molded in aluminum set screw insert
- * Full 1 1/2" legal width 1.4 legal diameter
- * "D" compound highest traction sheet foam tires glued & trued

SERVO SAVER 2 PIECE MOLDED

- * Low profile
- * Adjustable tension spring
- * Adjustable movement arms

BUMPER — made from real Kydex®

- * Pre-lightened & drilled

BATTERIES

- * Top quality G. E., sub C size, fast charge cells
- * Wired w/heavy gauge flexible wire
- * Assembled cars have dip-sealed pre-wired packs

RESISTOR ASSEMBLY

- * Top quality 1 ohm Parma-wound w/adjustable brake winding
- * Easy change heat sink resistor mount
- * Complete with optional diodes to drop voltage & protect the receiver
- * Brass wiper arm and bronze high current contact button
- * Assembled cars are pre-wired

ACCESSORIES AVAILABLE ON SOME VERSIONS OR MAY BE ADDED

- * Charge cord w/built in resistance
- * Differential rear axle assembly
- * Ball bearings for front wheels
- * Ball bearings for rear axle
- * Electronic speed control
- * Assorted main gears—46T, 48T, 50T
- * Assorted pinion gears—10T, 11T, 12T, 13T, 14T
- * Assorted painted or clear bodies
- * Assorted modified or custom motors

hobby spot

516 Hagley Road West
Oldbury. Warley
Worcs. B68 0VZ.

TEL: 021-422 1000

1/12 ELECTRIC CAR SPECIALISTS

Phil Greeno "Gemini" 1/12 electric car kit now available not the cheapest kit but could be the best excellent value at £79.00 All "Gemini" spares and parts also in stock.

NEW! Improved Associated stub axles with retaining buttonhead Phillips screws instead of circlips (2 screws 2 stubaxles drilled & tapped, 2 washers, 2 circlips) per set 98p.

MOTORS		AVAILABLE AUGUST
Mabuchi RS 54	£4.75	(hopefully)
Mabuchi "Redspot"	£4.75	NEW HOBBYSPOT 1/12th
Astro 05	£6.05	ELECTRIC CAR
Astro 05 Red Label	£6.65	CATALOGUE. Tips, pics.,
Igarashi "Porsche"	£9.75	all go fast goodies. Only
Igarashi "Lotus"	£16.25	45p.

1/12 BODIES IN POLYCARBONATE AND ABS

Too many to mention. We got lots. Polycarbonate unpainted from £4.95. Polycarbonate painted from £6.95. ABS from £2.10. Special Paint jobs to order.

SPECIAL ITEMS

Super 6-speed controller (Les Pipe)	£4.75	Ballraced Rear Axle Blocks (Mardave)	£3.95
Wiper Arm complete	65p	Ballraced Alloy Axle Blocks (Special)	£7.50
Parma Speed Resistor (Associated)	£5.23	Schumacher Differential all models	£6.95
Mardave Speed Controller	£3.50	Quick change Stub Axles suit Mardave	65p
Alpha Speed Controller (Recommended)	£3.95	Rear Wing Mounting set (Greeno)	£1.38
Associated Front End kit		Alloy Front Wheels Super suit Mardave	£3.50
Associated Front Wheels		AMPS Differential	£11.44
Front Wheel Ballraced (Associated) pr.	£3.85	Ni-Cad Rapid Charger 6 x 7.2v	£12.95
Lexan Chassis Plate 7 x 14	£2.50	Electronic Speed Controller with forward, reverse and braking	£34.00
Fibreglass Chassis Alpha	£3.95		
Ballraced Rear Axle Blocks Alpha	£4.60		

TYRES! TYRES! TYRES!

Raydio Soft, rear pair	£1.80	
Raydio Soft, front pair	£1.20	STOP PRESS
Raydio Med Soft, rear pair	£1.80	
Raydio Med Soft, front pair	£1.20	Team Hobbyspot
Raydio Hard, rear pair	£1.30	1,2,3 at Rotherham
Mardave Std. rear pair	£1.45	MotoCross Rally
Mardave Std. front pair		driving superb
Mardave Med Soft, rear pair	£1.70	TAMIYA ROUGH-
Lectricar, rear pair	£1.35	RIDERS - all kits &
Lectricar, front pair	85p	spares available
Palma Soft, rear pair	£2.20	

RECHARGEABLE BATTERIES, etc.

AA Cells	Special Offer £1.00	5 Cell Rechargeable	Special
Sub C Ni-Cads Saft	£1.95	packs, ideal for	6 and 7.2 volt Rapid Charger
Sub C Ni-Cads Std.	£1.90	Tamiya cars, etc.	with timer, 12 volt source
C Size Ni-Cads	£2.95	only £10.99	only £
Selected Saft Sub C Ni-Cads (120%) (Used by Team Hobby Spot) £2.75 each			
Most Cells also available in packs of 3 if required.			

1/12 Schumacher Differentials to fit Mardave, Lectricar, Associated, tc. Always in stock PLUS all spares

KITS

Mardave Lola or Wolf Real Value	£42.50	Tamiya Cheetah	£52.00	Mardave	All Spares Stocked for
Lectricar Porsche, BMW. Excellent	£49.95	Tamiya XR311	£46.50	Lectricar	
Antares latest from SG Racing Cars	£42.50	Tamiya Porsche 936	£39.00	Phil Greeno Gemini	
Cambria front wheel drive	£36.95	Tamiya 6 wheel tyres	£39.00		Most Spares available for
Graupner Porsche Can-AM FWD	£54.25	RC10 Race Car	£29.95		Cambria FWD and Associated
Plus the Phil Greeno "Gemini" kit, beautifully made and a winner at only £79.95					

MAIL ORDER SPECIALISTS

Telephone 021-422 1000

Mastercard, Hobbycard

Access, Visa, H.P. Terms

Opening Hours: Monday-Friday 9.30-6.30. Wednesday CLOSED.

Please allow sufficient for P & P

All Prices correct at time of going to press but subject to alteration.

NEW!

1/12 SLIP ON TYRES

1/12 slip on tyres using the new Flexi Tube inserts will fit Mardave, Schumacher and Leatherland Hubs. Ready tried

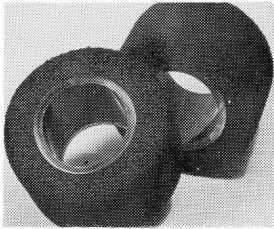

Soft Rears only £2.20 per pair

A NOVICE BUILDS A PB7 INTERNATIONAL

By Peter Townsend

THIS IS AN UNEDITED REPORT FROM A TYPICAL CLUBMAN BUILDING HIS FIRST 1/8TH SCALE CAR WITH ONLY 1/12TH BUILDING EXPERIENCE, CARRIED THROUGH TO TRACK TRIALS AND FIRST CLUB RACE.

Car ready to race. Half scale human male is real and not a model!



For the last three years as a member of the Yorkshire R.C.M.C.R.C. I have been racing a 1/12th electric car, and been involved with 1/8th scale in various ways, from general pest to team manager with some interesting results. In this time I have heard many expressions and remarks alluding to all kinds of weird, wonderful and technical sounding things: percentage of nitro, tuned pipes, idle bars, slide carbs, slip angles etc. etc.

A very trusting club member (Muriel Russell) let me try my hand at controlling one of these wonders of modern science, and I thought racing one of these cars couldn't be all that hard. (With hind sight - well - we all make mistakes sometimes don't we?). So - I got a car to race and find what all those problems were really all about.

Being interested mainly in racing in the club, with the occasional local open meeting, and not out to oust Mr. B., I accepted a Vecoy which was offered to me as a good economical engine and a P.B.9 as a top class race car. Having looked at the cars of experts and novices, talked to both levels of driver, the difference in preparation is pretty wide. I thought I would try and put down what hints and tips I could to try to assist drivers not in a position to plague the experts with problems, large and small.

The car comes with the parts packed into all the sections and each sub assembly has its own building instructions,

complete with a general instruction sheet with a building sequence. Also it contained a list of P.B. tyres and their characteristics. When opening the packs do so carefully by cutting one end to use these later.

The chassis and rear axle assembly has no problems, but if the gear carrier is a nylon one cut out a half round section to make it easier for working on the clutch. The alloy gear carrier already has this cut out.

Before assembling the disc brake assembly, using a junior hacksaw, cut a shallow slot in the top of the cam spindle, it makes adjusting a lot easier. File the shoes to a chisel like edge so that they help clean the discs in dirty and wet racing conditions.

If the brake shoes are fibre and the disc steel, it helps to fit a dummy pad between the cam and the fibre pod. This stops the cam wearing a groove in the fibre pad.

When fitting the engine and clutch, great care must be taken with the clutch. Study the instructions on the reverse side of the fitting instructions sheet. Cutting the clutch wrong will ruin it, and it is start again time. To fit the engine to the mounts, mark off the hole positions for the engine, and if the equipment is available drill from the bottom, counter sink counter bore and tap the blocks. Fit the screws with thread lock, they will come loose otherwise. Fit locking washers and locking nuts on the top.

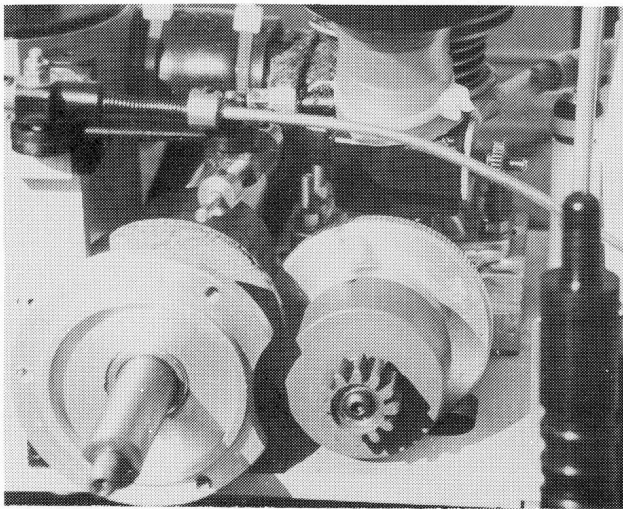

Show alloy gear carrier for diff., little arc now cut out for easier access.

Note neat fitting plus cable ties of silicon tube to exhaust.

The front axle kit is straight forward. All that was needed to do was clean the bearing holes in the blocks. A scalpel or modelling knife is adequate for this. Any stiffness in the king pin will go with racing. I assembled them and the steering ball-joints using a drop of Teflon lubricant. If your car has wire track rods, make sure that they are retained using collets, 'Z' bands or similar. To help with adjustment use centre out of electrical connector.

When the front axle has been fitted, check the measurement between the front and rear axle on both sides. If there is any difference in these measurements, the car will not run straight under power and braking.

Assemble the servo saver as per instructions and make sure it is working correctly. If you have a car without one, get one and fit it. I have seen a servo output disc broken, even with a servo saver fitted. Servo repairs are expensive.

When fitting the servos check that the mounting holes in the chassis, if drilled, line up. The servos I use, Linward, are a little wider than the holes in my chassis allow for, so two more holes are needed to be drilled to fit the mounts. On the steering servo mounts, a tie rod across the top helps to keep the mounting firm. I fitted balljoints on the servo to servo saver, these being easily adjustable compared to the rod type. Make sure all connections and links are set up at 90 degrees through the centre of the movement. Having these out of "square" could result in more steering to one side than the other. Do not forget, if piano wire rods are used on the

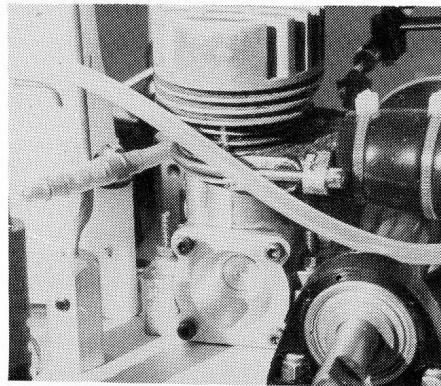

steering, or elsewhere, retain the ends with 'Z' bands or collets. This is most important.

When assembling the linkage to the brake throttle keep the rods as straight as possible, sharp bends give, resulting in no brakes and/or no throttle. Again retain rod ends, a throttle linkage dropping off at full revs, or a steering rod dropping off can cause a lot of damage to people, not to mention the car. Lock collets and nuts tight, if it can vibrate off or come loose, it will.

Fitting the carb to the engine, some people use epoxy resin and some just use liquid silicone rubber as well as the screws. Not liking to use a hammer and chisel to remove the carb, I used silicone to seal and help retain the carb. Seal the ends of the silencer with silicone also, and use silicone tube to connect silencer to

engine. I fastened mine on using electrical ty tapes. NEVER RUN ENGINE WITHOUT SILENCER. Your ears, and neighbours, don't like it. When racing, if your silencer falls off through crashing STOP immediately. Use a silencer that works. Some on the market do not work very well at all.

Before fitting fuel tank check for leaks. Connect silicone fuel tube to tank, put tank in clean water and blow gently, watching for bubbles. Mount tank on flexible mounts to stop vibration frothing of the fuel. Always use a line fuel filter, it is surprising how much dirt gets into the fuel. I used a klap trap, it has the advantage that the filters can be seen, so that you can tell if they are blocked or not. Pressurising the fuel tank from the silencer helps in the setting of the carb, and keeps the setting constant. Without pressure feed the engine would run rich when the tank is full and lean out when getting low on fuel, due to the relatively high change in fuel level. Consistent running on a weak mixture will eventually damage the engine.

Once the engine and carb have been set and run correctly, the carb shouldn't need resetting every time the engine is run. If the engine keeps stopping check the plug, if a new one is fitted throw the old one away. (It is no use keeping a plug that is suspect, it could be fitted in a race by error giving problems that will be hard to find). Check the fuel filter is not blocked, it happens rather easily. Check the fuel tube has not got any kinks in it or splits. Always use silicone fuel tube, neoprene goes hard with age and heat, silicone does not.

After each session of running drain the fuel tank, run the motor with the starter to clear all the fuel from the tubes and carb. Put some 3 in 1 or similar light oil in the carb and spin the engine a few times. This helps to stop the castor oil from the fuel settling in the bearings, drying and poss-

ibly causing trouble the next time the engine is used. Always glue the tyres to the hubs. That may seem a silly statement to make, but I have seen someone turn up to race without glued tyres. It is not to be recommended. Clean any moulding flash off the hub and roughen the face with coarse sand paper to give a key for the glue. Use an impact adhesive such as Evostik or Bostik. Coat the hub with glue and the inside of the tyre and leave to dry for 2 - 24 hours. Fix the hubs, outer rim down to a piece of wood, not dining table using wood screws. 'Wet' the glue on the hub with a light smear of glue and 'Wet' the glue in the tyre also, immediately push the tyre on to the hub and down to the board. Do each hub and tyre in turn, if the glue starts to dry, the tyre will not push on the hub. Remove the wheels from the board and true up. True the tyres so that the two front tyres are the same size, also the two rear tyres have to be the same size. The simplest way to true the tyres is to fit the wheels on to spindles, fit into lathe or drill stand and use coarse sand paper on a block and sand the tyres true and to a matched pair of the same diameter. Round the corners of the tyres, the rear to about 1/4" (or should that be 6mm) radius. This helps to stop the tyre 'chunking' or breaking up until it is run in, particularly on high grip tyres. Fitting and truing tyres in this way is not guaranteed, 50% handicap drivers have been seen to shed tyres, yes tyres, in practice sessions, but at least 95% of the time it will work.

As a stock of wheels with tyres are collected it helps if you know which are which. Purchase some small white sticky labels, write on the tyre type e.g. 371,374 etc. Stick the label on the inside of the hub and coat with fuel proofer. It will assist sorting tyres on future occasions.

When the tyres have been trued, fit the

Careful servo installation. Short straight leads: plus tie rod to make doubly secure across the top.

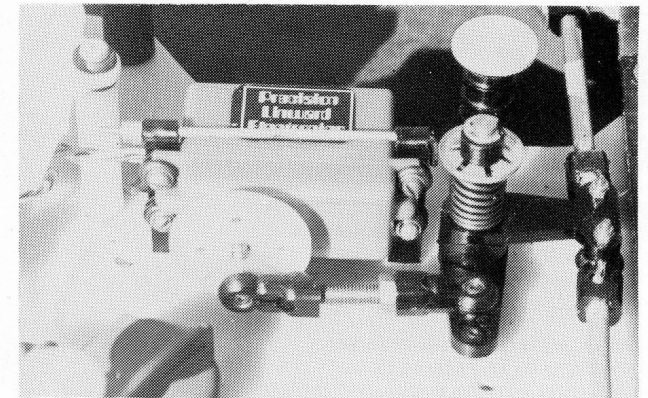

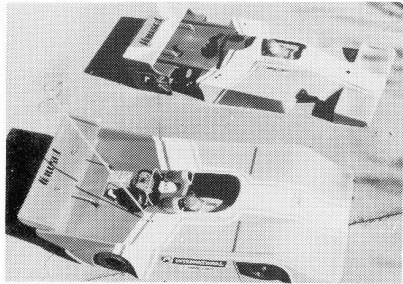

More thoughtful care! Cheap ABS bodyshells for test runs not to risk nicer (more expensive) Lexan shells.

wheels on the car, check the chassis for 'tweak'. With the car on a flat level surface, lift one of the front wheels until the other wheel just lifts, and measure the amount of lift on the first wheel. Repeat the other way round and check that they are the same. If they are not the same the car will oversteer on one lock and understeer on the other. Oversteer is when a car, when driven round a corner, spins the back end so the car spins in the direction of the turn. Understeer is when a car tries to go straight forward when the car is steered for a corner.

If your car does have unequal lift at the front wheels, carefully shim between chassis and beam until the lift is equal. Repeat this check on the rear wheels also, and shim the axle blocks if required.

When fitting the front bumper cut the corners with as a large a radius as is possible. If one is hit on the leg by a sharp corner, it is painful.

With some bodies it is possible to cut the front bumper so that it is a close fit inside the body. Doing this gives less chance of the car getting stuck into other cars on marker boards in the event of a collision.

Fitting the radio has no problems. Mount the on-off switch to the chassis directly or on a bracket. Do not use servo tape, the fuel will attack the adhesive and the switch may come loose in a race. Fitting the switch in a balloon and taping the neck of the balloon keeps water out, or fill the switch with silicone grease. Plug the receiver battery to the switchlead, place it and the plug and socket in one of the plastic bags that the parts came in, put two rubber bands round it and hold them on with insulating tape. Stretch the rubber bands on to the radio mounting pillars. Repeat with the radio receiver.

If using a Tx with stick controls make sure "right" on the steering is right on the

car and the stick is spring loaded to centre. The same applies to wheel Tx's. On the throttle stick it is almost impossible to control the engine braking without a spring centre loading on the stick. It could help if when the stick is pushed away it opens the throttle and pulling the stick back applies the brake. Most drivers use this system and if you would like a driver's opinion on how the car handles, it helps if he can drive it.

Do NOT mount radio components to the chassis with servo tape on 1/8th scale cars. The receiver likes the vibration as much as water i.e. **not much**.

Body fitting is simple enough, cutting holes to clear the engine, air cleaner etc. The maximum hole sizes are laid out in the B.R.C.A. handbook along with tyre sizes and other information. Not wanting to risk damaging the Lexan bodies supplied in the kit, I fitted two A.B.S. bodies the new shadow G.T. and the Lotus 80 F1. These are also easier to paint and cheaper to replace while learning to drive the car.

After painting with car aerosols the bodies were fuel proofed.

The Yorkshire and Wombwell car clubs had arranged a home and away interclub meeting, so I thought this would be an ideal opportunity to test the car out. The first leg was run at Wombwell. I found that I had set the steering up a bit out of trim so I adjusted it to run straight when the T.X. trim was at the centre position. Also I had set the throttle/brake linkage so there wasn't any 'free wheel' at centre stick position, either the brake was applied or the carb was opening. With assistance and advice from a club member it was reset to let the car freewheel or tick over.

The brake was a bit harsh, being new, but I later discovered that the disc was slightly thicker on one half than the other. Five minutes with an emery cloth cured this.

The weather at Wombwell was fine and dry but rather cold. While practising and getting used to the car and track, I had difficulty getting round the first bend of the main straight. Before the racing started I looked down the track from one end and saw the bend had a straight in the middle, so I thought, look at the rest of the track, and any other new tracks in the future. I qualified for the 15 min. handicap final with a best heat at 10/324. The handicap final had three drivers from each team, as had the Open final.

Warming up for the handicap final I must have had a small stone between the clutch gear and the wheel gear. On the

(continued on page 24)

SANWA DIGITAL PROPORTIONAL RADIO CONTROL SYSTEMS

Every picture tells a story!

If you would like a further dialogue on IRVINE-SANWA products, please contact your local dealer, or, send large (A4) S.A.E. to:—
IRVINE ENGINES LTD.,
UNIT 2, BRUNSWICK INDUSTRIAL PARK, BRUNSWICK WAY,
NEW SOUTHGATE, LONDON N.11

IRVINE  **SANWA**

CHALLENGER

EXPERT 300

Per Gustafsson displays his latest model at the 1980 Nuremberg Fair.

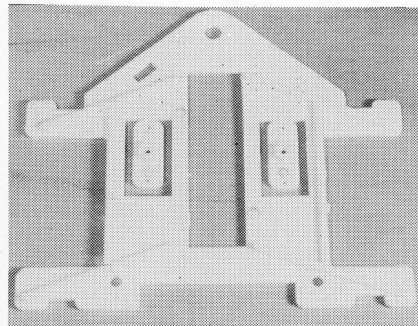

Radio plate bonus! Cutouts for servos used to provide tailored servo arms!

We can say straight away therefore that the Minicars is fairly long established with several years of development behind their product. The first car the company produced was of a very experimental nature, being largely moulded at no little expense. I believe this initial effort was assisted by their government by way of a grant. Anyway it proved insufficiently robust for international class racing though a beautiful production job elegantly presented. It found a modest place as a good club model though can never have recouped its moulding costs.

Out of this effort grew Per Gustafsson the No.1 company driver and their main driving force. The 1977 Euro Championships held on the beautiful Paul Ricard circuit near Lyons gave him his first notable victory in the Sports/GT Class—a clear cut win by over five laps. Unfortunately for the young company it was driving a basically Associated car sporting Challenger wheels! This may be the reason why the currently developed Challenger has something of an Associated flavour. After all, imitation is the sincerest form of flattery.

Be that as it may the Challenger can stand very well on its own four wheels with enough distinctive features of its own to justify its choice. A very substantial power pod, some 3/32in thick mates with

Stout steering crossbeam and steering linkage.



INTEREST in Swedish made cars has been rather limited by the absence of distributors in G.B. so that I am particularly pleased to have this car for review by courtesy of Ray Parker of Raydio Tyres, who is taking up the kit to sell in this country together with the as yet unreleased 1/12th scale car from the same stable. Long term readers may remember that a line drawing of the Swedish Challenger appeared in the very first issue of this magazine in 1977.

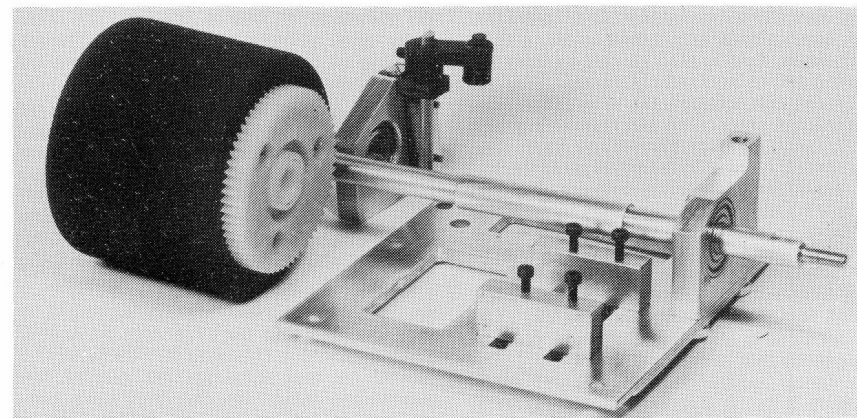
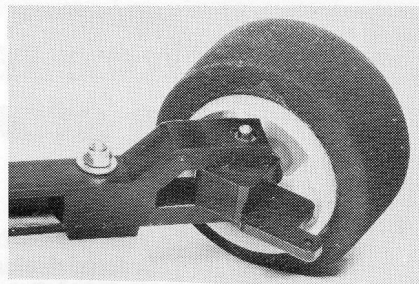

a waisted GRP chassis. A stout black moulded nylon crossbeam takes care of the steering with a sharply angled degree of castor. Strong moulded steering blocks take the stub axles. Wheels are bushed as are the kingpins. Circlips hold the wheels in place. The nylon wheels drilled for lightness are specially attractive. The whole front unit goes together very easily.

I should add that the basic illustrated building instructions are in Swedish but accompanied by very lucid translation in English which leaves nothing in doubt.

Robust steering arms of the usual adjustable ball and socket type connect with the servo-saver which follows the spring loaded original American style but with a very wide range of attachment points for the steering servo. Going now to the power pod, this provides slotted attachment points for the engine mounts, massive plummer blocks in alloy for the

axles, which run in ballbearings Block on the drive side is slotted and drilled to take the disc brake mount, and both are drilled

Power pod, showing adjustable engine mounting blocks, axle and ball bearings. In background disc brake unit and driving wheel with gear attached. Below brake gear in detail and general arrangement drawing.

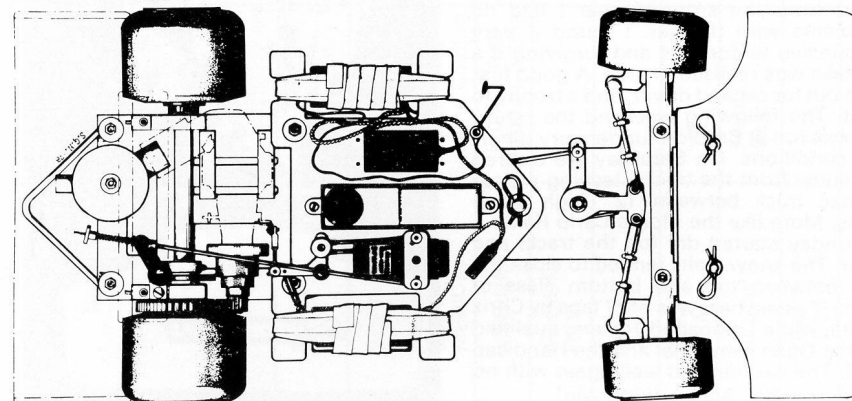
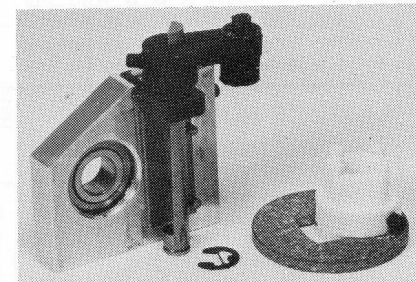

to receive the wing mounts. Disc is of fibre with steel shoes and brake lever is fully adjustable. Pod is also drilled to take silencer dustbin and rear bumper.

Radio plate is especially interesting. It is a moulded piece with strengthening ribs under, with cutouts for servos each side of a central cut out to take fuel tank. Recesses are indented each side for radio and battery mounting, with niches to take the supporting rubber bands. In each servo cutout a stout servo arm suitably slotted to fit Futaba and similar servos is treed in and only needs to be cut away. A neat little bonus that uses up the material!

Fuel tank is standard Johnson type in two pieces that requires to be soldered up into usual sump/chicken hopper style without frills. It presents a useful little exercise in soldering, which is apt to get a bit rough if not practiced regularly. I use a coating of Fryolux (solder paint) for jobs of this sort plus a butane blowlamp or even my old meths lamp if I've forgotten to get in a gas cylinder.

What remains? A straightforward dustbin silencer that bolts into place and the two alloy front body mounting posts. Then engine of choice must be installed - I am using my trusty K & B with the Delta silencer. Apart from its looks, which I am growing quite to like - it does the job well, and anyway I have machined the fins

A NOVICE BUILDS A PB9

(continued from page 20)

starting horn the wheel gear stripped. Good work by "my mechanics" had a new gear fitted in about 3½ minutes and I entered the fray. By the the end of the 15 minute final I had managed to work through to third place.

Altogether a satisfactory day's racing, apart from the stripped gear I had no problems with the car. I found it very responsive to controls and forgiving if a mistake was realised in time. A good first time out for car and driver, and a trophy to boot. The following weekend the return leg was run at Bradford under very different conditions. On Saturday we cleared the snow from the tracks, leaving a clear tarmac track between 12" high snow walls. More like the Monte Carlo Rally.

Sunday started dry (on the track) and clear. The snow walls tended to close the gap between top and bottom class of driver. Fastest heat was of 17 laps by Chris White, while I managed 14 laps, qualified for the Open semi-final and the Handicap final. The car handled well again with no problems. No! Alas, I didn't win!

off the head: to this is attached the slide carb and airfilter provided by Speed-models of Switzerland which mates up very nicely with it.

I had a chat with Per Gustafsson at Nuremberg on the Minicars stand and saw his very latest offering. It is much the same as this with the exception that he has found a source of countersunk aircraft type screws which neaten the underside of the chassis and has waisted the GRP RATHER MORE SYLPHLIKE THAN HERE.

Mike Newman has been a faithful devotee of the Challenger for a couple of seasons now and runs his with an AMPS silencer and diff. I hope to persuade him to provide a few running tips out of his experience when he can find time between moving house and looking after 1/12th scale interests. But more anon.

In the last month or two the supply position has become somewhat confused, since the company manufacturing parts for Per's Challenger have started to market their own somewhat similar kit under the name of Sigma with the original Challenger continuing as before. Mike Newman and his team mates therefore now call the car Sigma-Challenger . . . Perhaps visitors to the Euro-Champs in Gothenburg this summer will be able to unravel the situation on the spot.

Finished car, waiting only battery and Rx to be ready to go.

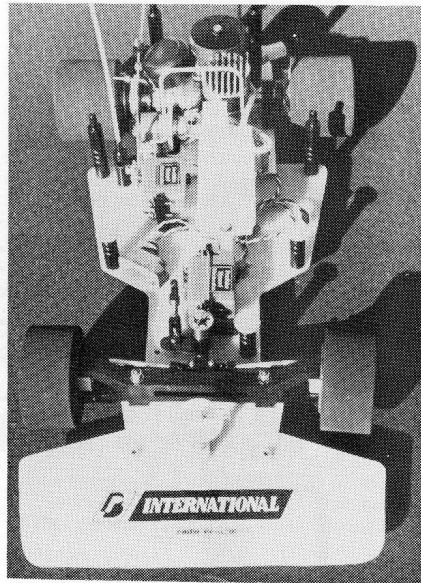

R/C TYRE SELECTION CHART	CONCRETE, GOOD TRACTION	CONCRETE SLIPPERY	ASPHALT RACING SURFACE WITH GOOD TRACTION	SLIPPERY ASPHALT RACING SURFACE	ASPHALT, PARKING LOTS VERY SLIPPERY	CARPET	GYMNASIUM FLOOR, VINYL, LINOLEUM, ETC.	FRONT AND REAR WITH SILICONE COATING	FRONT WITH SILICONE COATING	FRONT WITH SILICONE COATING (FRONTS) WITH SILICONE COATING	FRONTS	FRONTS (FRONTS)	FRONTS AND REAR	FRONTS (FRONTS)	FRONTS & REAR	REAR (VERY GOOD)
SUPER SOFT		Rear		Rear	Rear	Rear (Fronts)	Front and Rear With Silicone Coating									
SOFT	(Rear)	Rear		Rear	Rear	FRONTS & REAR	FRONT WITH SILICONE COATING									
SOFT MEDIUM	(Rear)	Rear	Rear	(Rear)		FRONTS & REAR	(FRONTS) WITH SILICONE COATING									
MEDIUM	Rear					FRONTS (REAR)										
MEDIUM FIRM	Rear & Fronts		(Rear)			FRONTS										
FIRM	Fronts	Fronts	Fronts	Fronts	Fronts	(FRONTS)										
VERY FIRM		Fronts	Fronts	Fronts	Fronts	(FRONTS & REAR)										
SKUNKS						FRONTS & REAR										
TRACTION CUTS					(Rear)	REAR (VERY GOOD)										

NOTE: This chart is only a guide. There is always an AJ's tyre that works best on your surface. Experimenting will find the best for you.

AUTO Modeller

radio control MODEL CARS

THE GREAT DRIVE FORWARD

Until now RADIO CONTROL MODEL CARS has been obtainable roughly every other month only from model shops with an active r/c side or by direct subscription throughout the world. With a rapidly expanding hobby demand has been increasing to the extent that the magazine has been straining at its "cottage industry" bonds. How fortunate that just over a year ago AUTO MODELLER arrived on the scene as the only all-car monthly magazine on the British market.

I am now very happy to announce a working arrangement with AUTO MODELLER which will be carrying a regular r/c cars supplement to the infinitely larger readership that a magazine in the newsagents and bookshops embraces. It will be the first time that such coverage has been possible. I never sought it since it entailed capital outlay far beyond what I could contemplate: now it is here. Any regrouping

with a general model magazine would have risked submerging its interests; now with a fellow car enthusiast mag it can enlarge the original AUTO MODELLER appeal as well as give the new r/c readers an insight into the joys of collecting and re-awaken their interest in the smaller scale slot car racing to which so many current drivers owe their introduction to model cars.

Page size (11 x 8½ ins) of AUTO MODELLER is considerably larger than RCMC's A/5 pocket size so that bigger pictures can be expected with as least as much text. Monthly appearance will also answer the demand of so many enthusiasts: "Give it us now!"

The first issue under this new arrangement will be appearing the shops and news-stands at the end of August under dateline of September price 60p.

TWINN-K AJ'S TYRE TABLES

SUPER SOFT

800 and 810 Fronts and Rears (900-910): Specially developed for silicone coating. Gives perfect base for all kinds of indoor racing on lacquer, vinyl or rubber surfaces. Not available with silicone coating from factory.

SOFT

811 Rears (911): Very good traction. Soft universal rubber for all kinds of slick racing surfaces. May bounce when traction increases. Also works well with silicone coating when traction is very good and 810 start bouncing. Works well on carpet.

801 Fronts (901): Perfect for silicone cover. Can also be used on high traction tracks without silicone.

*SOFT MEDIUM

812 Rears (912): Provides very good traction on most tracks. May bounce on well broken-in track. The best on carpet.

802 Fronts (902): Can be used with a silicone cover on very slippery tracks. Good for high traction tracks without silicone. Also works well on high traction carpets.

*MEDIUM

813 Rears (902-912): Same compound as 812 and 802, but firmer. Works best on broken-in tracks, and has little bounce. Very good on carpet.

803 Fronts: Best on carpet and other tracks with good traction.

MEDIUM FIRM

814 Rears (914): Works good on high traction tracks and some types of asphalt. Racers from some areas of the world think this is AJ's BEST.

804 Fronts (904): The universal front tire works well everywhere.

FIRM

805 Fronts (905): Works well on average traction track.

VERY FIRM

806 Fronts: Our rock hard tire - best for slippery tracks and novice racers.

*AJ's Soft Medium and Medium Rubber Compounds are the same - but hand picked to prevent the racer from getting two shore hardnesses in the same pair of tires.

145,
NEWGATE
LANE,
MANSFIELD,
NOTTS.
TELEPHONE
MANS. 36062

JIM
DAVIS
MODELS
LTD.



R/C SPARES
AND ACCESSORIES

145,
NEWGATE
LANE,
MANSFIELD,
NOTTS.
TELEPHONE
MANS. 36062



BIRMINGHAM
1/12
INTERNATIONAL
RACE 198
ENTRIES!!! 9,000
SPECTATORS!!
WALLY BAILEY is
Top Qualifier in
BOTH Stock and
Modified Classes
and WINS
Modified Classes
with his
ASSOCIATED
12E car powered
by a REEDY
Modified motor.

WORKS
REPLICA
ASSOCIATED
RC 12E 1/
SCALE
ELECTRIC, ALL
THE LATEST
FROM THE
FACTORY IN-
CORPORATED
IN THE CAR.
PHONE FOR
DETAILS

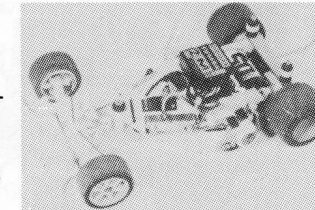

NEW RADIO CONTROL OUTFITS

Futaba 2L with 33m servo's	£44.00
Futaba 2L with 17m servo's	£58.00
Nicad conversion for above, inc. nicads, charger, charge jack and leads	£24.50
Sanwa 2 with 2 servo's	£42.95

SPECIALLY REDUCED

Acoms 2ch. plus 2 servo's	£29.95
---------------------------	--------

1/8 SCALE CAR KITS & ACCESSORIES

PB6 International	£79.80
PB7 International	£70.40
PB8 International	£95.32
PB9 International	£127.27
P10 International	45.95
S.G. Futura III Special, inc. diff.	£90.95
Mardave Comp. Special	£29.80
Mardave Stock Car	£26.50
Mardave Autocross Special	£26.50
P.B. Air Filter £2.90	P.B. Differential £39.85
P.B. G.R.P. Chassis (narrow)	£9.27
P.B. G.R.P. Radio Plate	£8.50
P.B. Slide Carb.	£27.50
AMPS Mini-Diff PB £35.00	AMPS Mini-Pipe £13.90
P.B. Adjustable power silencer	£15.92
Greeno tuned silencer	£16.95
Full range of Phil Greeno acces. including Supacar Lexan Paint.	
Parma Big Shot fuel bulb	£3.25
Delta servo savers £4.85	Delta Linkage kits £2.30
Delta air filters £2.85	Delta track rod kits £4.55
Delta fuel filter £1.98	Delta antenna £1.75
Johnson Fuel tank kit	£1.95
Associated flip top	£3.75
P.B. Tank (flip top) nylon	£5.50
Thorpe rear hubs (pair)	£2.20
Ballraced servo tops 17m	£4.50
Parma genuine Lexan paint all colours and thinners, two sizes.	
Associated 2402 £4.25	Associated moulded front £4.66
Uffra Slix, Specials, Supers. 3 dot all weather tyres	£4.95
P.B. 215 all weather sticky's	£5.00
MRP mid. fronts £4.25	Delta 340 B £4.25
Plus full range of P.B. tyres and full range of bodysHELLS by P.B., Parma, S.G. and M.R.P.	

LATEST RELEASES

P.B. Clamp on clutch ass.	£15.73
P.B. Digital stopwatch	£17.50
S.T. X21 R.E. 80. Inc. Manifold	£59.90
Jim Davis Models Hi-Torque racing 05 motor. 35 turn armature stock production and LEGAL	£6.50

CAR ENGINES

OPS 21 with carb.	£52.65	OPS 21 without carb.	£49.95
K & B 21 without carb.	£39.95	OS 21 FSR A.B.C.	£52.00
Picco 21 with slide carb.	£84.00	Irvine 20	£41.95
Veco 21	£31.75	Veco 19	£27.95
Fuji 19	£27.40	Hi-Speed main bearing	£8.10
OPS slide carb.	£21.00	Filter for above	£1.50
Sullivan starter.	£26.50	P.B. Nova starter	£22.86

1/12 SCALE KITS & ACCESSORIES

Associated competition basic rolling chassis (basis of the works replica cars)	£36.95
Associated basic kit	£29.95
Associated full kit	£59.95
Phil Greeno's Gemini (chassis kit)	£45.95
Gemini competition kit	£85.00
Complete range of Gemini spares and accessories	
Lectricar full kit	£49.95
Lectricar stock car	£59.95
Mardave Mk II 6 cell	£42.95
Mardave 4 cell kit	£34.95
Mardave stock car	£36.50
Mardave Midget racer	£36.50
S.G. Antares	£36.95
Tamiya Rough Rider	£69.95
Tamiya Sand Scorcher	£69.95
Tamiya Comp. Specials, XR311, Cheetah Cambria F.W.D. kit	£36.95

M.A.P. Timer charger	£12.95
Tamiya fast charger 6v.	£12.99
Tamiya fast charger 7.2v.	£12.99
Tamiya 6v. and 7.2v. Nicad packs fast charge leads 4 or 6 cell	£3.14
Push-on tyres and rims trued and glued tyres on their own (pair)	90p
Rims on their own (each)	25p
Associated differential	£10.65
Schumaker diff.	£6.90
AMPS Mini-Diff 1/12	£11.40
Cambria diff. (F.W.D.)	£14.95
Full range of Parma motors, M.R.P. and Associated 05 including Reedy's when available. Parma, M.R.P. and Associated 1/12 bodysHELLS over 150 in stock from £4.95 clear to £7.90 painted including the latest from M.R.P. the	

AMPEX PROPHET CAN-AM

Parma speed resistor	£4.95
Associated speed resistor	£5.32

Soft Hi-Capacity 1.2 AH cells singles	£1.65 each or welded 3 cell packs £6.50 each.
Soft 500 M.A.H. Pencil cells each	£1.00

ASSOCIATED RC12E 1/12 SCALE ELECTRIC

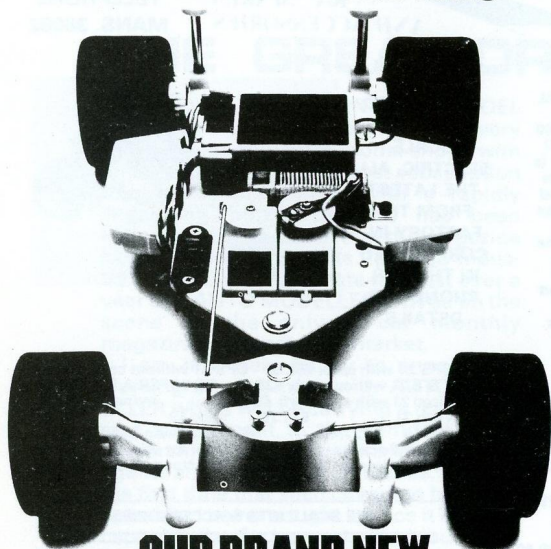

**OUR BRAND NEW
RC12E LOOKS LIKE A WINNER.**

IT SHOULD.

WESTERN REGIONAL CHAMPIONSHIPS
THORP RACEWAY, ROAR SANCTIONED
134 ENTRIES

Modified Class	Car	Motor
1 Gene Husting	RC12E	Reedy
2 Curtis Husting	RC12E	Reedy
3 Bill Jianas	RC12E	Reedy
4 Mike Rowland	RC12E	Reedy
5 Chuck August		
6 Bill Steele	RC12E	Reedy
7 Frank Killam		
8 Matt Azzara	RC12E	Reedy

Reedy Motors available from Associated
RC12E wins all four 1/12 electric races at
1979 Roar Nationals

ASSOCIATED, 1928 East Edinger, Santa Ana, CA 92705, USA

ASSOCIATED NEW 1/8 RC300

1979 INTER-CONTINENTAL RACES

Most teams have one or two Super Drivers. We believe our cars handle so well it enables more drivers to become Super Drivers EASIER and QUICKER. JOIN THE SUPER DRIVERS.

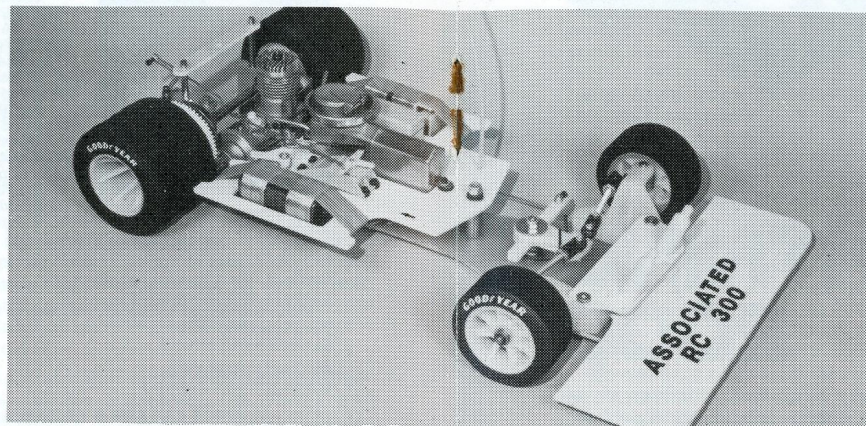

RC300



RICK DAVIS



DEBBIE PRESTON

At the WINTERNATIONALS race, BILL JIANAS qualified 1st with 32.8 laps, RICK DAVIS 2nd - 32.0 and JACK JACOBS 3rd - 31.9. BILL JIANAS was in the lead at 65 laps when he lost a front tyre. At the WORLD'S CHAMPIONSHIPS, Ishihara from Japan qualified first, CURTIS HUSTING 2nd, JEFF ROLD 3rd, BILL JIANAS 5th and CHUCK PHELPS 6th. At 38 laps. CURTIS was leading with JIANAS 2nd and PHELPS 3rd. CURTIS'S engine locked up, JIANAS'S engine died twice and PHELPS ran out of fuel giving the lead to BOOTH. At WEISBADEN, CURTIS HUSTING was TOP QUALIFIER and the only car to turn 21 laps. JIANAS lowered the individual lap record to 14.0 seconds and DEBBIE PRESTON was TOP QUALIFIER from the Semi's.

WINTERNATIONALS ORLANDO, FLORIDA USA

1 Rick Davis	Associated	USA
2 Mike Rowland	Associated	USA
3 Gene Husting	Associated	USA
4 Phil Greeno	PB	England
5 Bill Jianas	Associated	USA
6 Roger Curtis	Associated	USA
7 Arturo Carbonell	Delta	USA
8 Phil Booth	PB	England
9 Keith Plested	PB	England
10 Jack Jacobs	Associated	USA

WORLD CHAMPIONSHIPS GENEVA, SWITZERLAND

1 Phil Booth	PB	England
2 Bill Jianas	Associated	USA
3 Chuck Phelps	Associated	USA
4 Fujio Sasuga	AAT	Japan
5 Naoki Ishihara	Road Ace	Japan
6 Rick Davis	Associated	USA
7 Jeff Rold	Associated	USA
8 Ronnie Ton	Serpent	Holland
9 Dave Martin	PB	England
10 Curtis Husting	Associated	USA

WIESBADEN GRAND PRIX WIESBADEN, GERMANY

1 Rick Davis	Associated	USA
2 Debbie Preston	Associated	England
3 Franz Groeschl	Scratch	Germany
4 Peter Bervoets	Serpent	Holland
5 Bob Errington	PB	England
6 Ronnie Ton	Serpent	Holland
7 Phil Greeno	PB	England
8 Curtis Husting	Associated	USA

Available from: **IRVINE ENGINES**

JOMAC

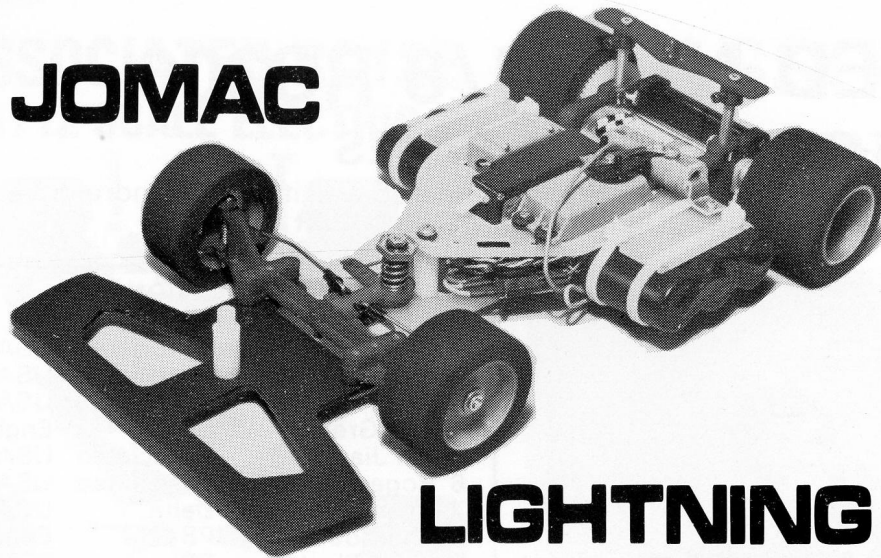

LIGHTNING 2000

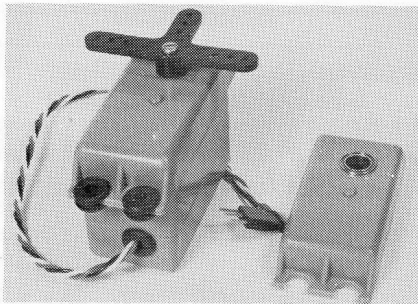

Heading: Rolling chassis fitted with resistor type speed controller.

Above & Below: Jomac servo with replacement ballraced cover and proportional speed controller with heat sink same size as servo.

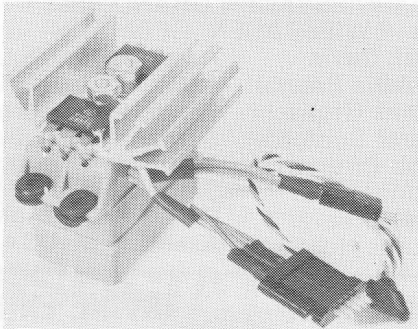

Seeking out modelshops with an r/c car interest on Vancouver Island is like mining for gold in Ireland but I did find one with the very interesting little 1/12th electric JoMac Lightning in stock. By a wonderful chance Don McKay had sent off a whole load of goodies to greet my return to England including a Lightning kit plus lots of supporting bits and pieces. The JoMac(or MRP) range has never attracted the following that it deserves in this country. For a time it was wholesaled by PB Racing Products but the terrific growth of that company's own range of 1/8th scale cars at that time meant that it never really got off the ground. However, the latest offering is so very much in line with the latest modern thought that a look at in detail should be well worth while. A few model shops I believe import it direct, but so far no one has taken up the main distribution – so there may be a good chance for someone.

In common with other American manufacturers I have noted with pleasure an ever improving instruction manual that goes with the kit. This is so much more than a how-to-do-it sheet that it is rightly available as a separate stock item. Don McKay has really put a lot into his little book, some of which I hope can be passed on to readers whether or not they succumb to the Lightning's charms.

Chassis assembly offers no special difficulties. There is 5 degrees caster built in steering crossbeam and care should be

taken to install right way round as it is symmetrical in shape. Lightened chassis is of .080 thick epoxy board with routed edges not stressed from stamping and attractively coloured in blue. Shaker plate is of same material but .060 in thick; moulded parts are of nylon, and black bumper plate is of Kydex, suitably lightened. Most parts, steering crossbeam, power pod, shaker plate are all in matching blue. Servo saver is assembled from parts and has a very strong spring which some users may wish to weaken. Shaker plate is extended to hold the nicads which hang down from it and are secured with the usual cable ties. A stock "ROAR Legal" .05 motor is provided. This motor is located forward of the rear axle and the power pod is very stout so that there appears no need for a rear bumper to protect the motor (famous last words? I hope not). Wing tubes fit neatly into socket provided. A resistor type speed controller is provided and this bolts onto the shaker plate. Servo fits neatly in front of it right way up: steering servo is inverted and fits on other side of plate with Rx in between.

However, a proportional speed controller is available that does away with the resistor/servo speed controller and fits in place of that servo – being indeed based on a container of same size. A heat sink is fitted with it for good measure. A good supply of spare plugs and sockets are included to make necessary connections. I like new gimmicks and this particularly appeals to me as much on account of using a servo casing as anything I suppose. The normal servos supplied can also be upgraded by changing their tops section to ballraced covers – a valuable thing in cars perhaps with the constant demand

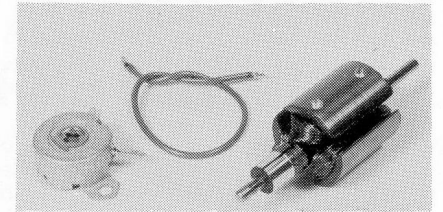

Adjustable brake pot and specially wound commutator assembly.

Below: Servo saver kit in parts.

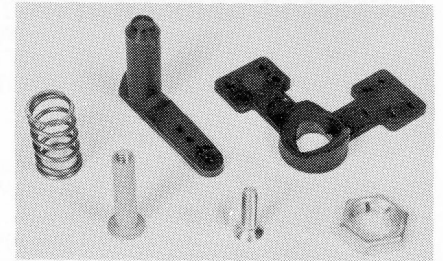

Jomac constant current charger.

Below: Lightning bodyshell in painted condition for Toj BMW (ours)

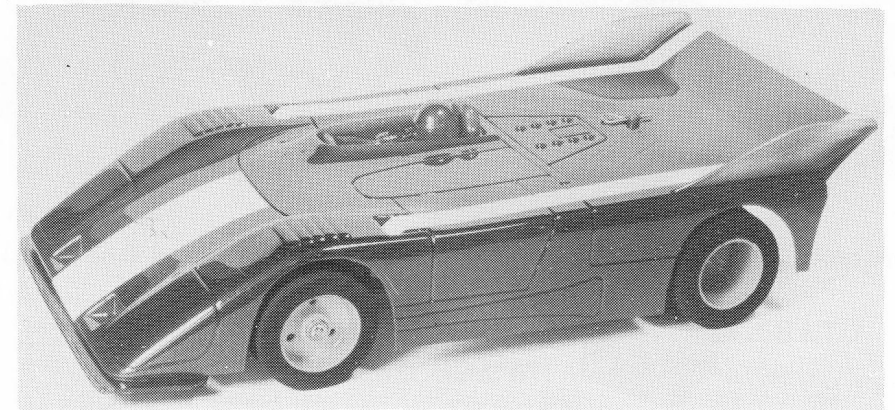
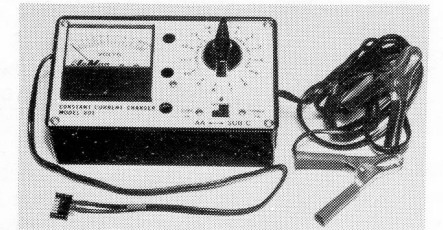

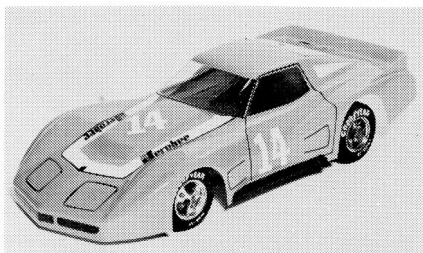

Above: Another painted up Jomac, the Can Am Vette and below ever popular Schkee. Top right steering crossbeam and stub axle units.

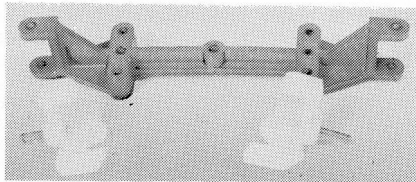

upon them rather than the more stately progress of an aircraft.

Not to omit anything likely to be useful Don also included his Constant Current Charger Model 801 in his packet of goodies. With so much thought given nowadays to kindness to batteries for long and hard life this is specially welcome.

Next in line for attention must be the bodyshell. My kit came with a nice ready-painted body (which if it lasts as my Jerobee body has will see me into 1984) TOJ BMW. For good measure I have also painted up versions of Schkee Lola and a hatchback Can Am Vette. These are most elegantly done and when I think of the moderate difference between clear Lexan and painted up (about half as much again) then I tend to put my spray gun and tapes to one side.

This little report introduces the JoMac marque once again to our readers. I hope in a further issue to give some idea of performance not only in my palsied hands but also as handled by one of our up and coming young drivers.

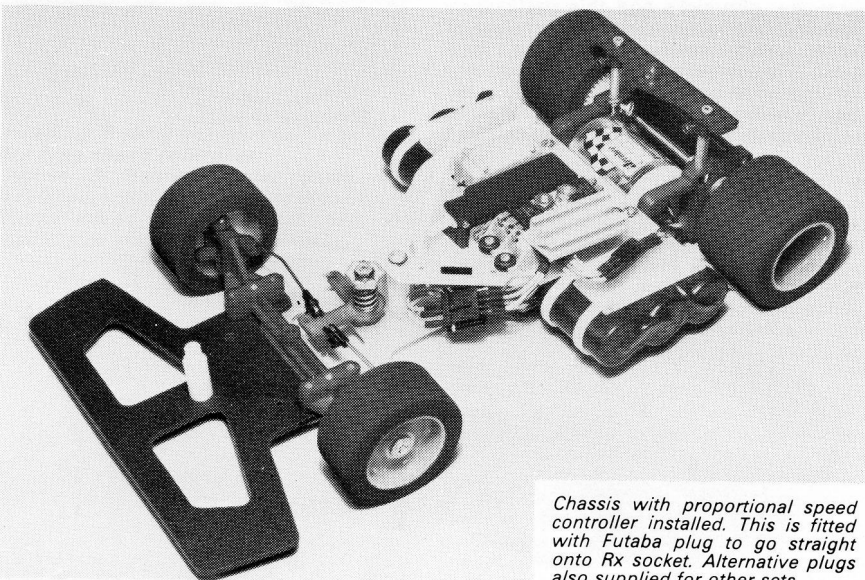
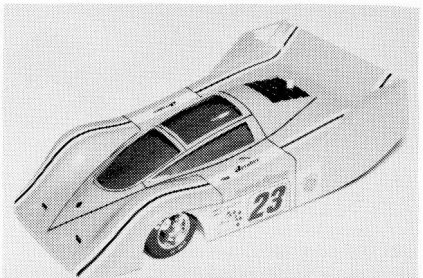

Chassis with proportional speed controller installed. This is fitted with Futaba plug to go straight onto Rx socket. Alternative plugs also supplied for other sets.

radio control EARLIER ISSUES MODEL CARS AVAILABLE



ISSUE 1 – A good starter! Making a Start with R/C Model Cars : Mysteries of Tuning : British Radio Car Association : Radio Stock Association : Electric Car Electronics : Electric Cars



ISSUE 6 – Painting Lexan Bodies : Delta Review : Monaco World Cup : Electrics : Stock Car Notes : Trade Reviews : Fuji 19-IV-SBB Engine Test Meeting Reports : Letters

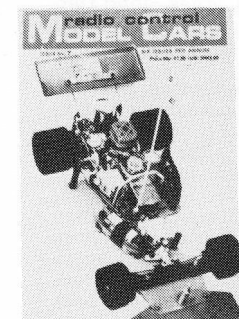

ISSUE 7 – PB-Greeno Special (Monaco Winner) 24-hour World Record Runs : StockCar Racing Holland : Making Mantua Kit : Wing Aerofoils : More Electrics : Something Differential : Club Meetings

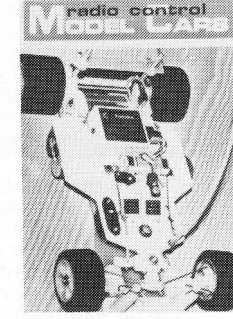

ISSUE 8 – Associated RC12E Electric Car Review : SG Futura III Built : Stox on Maggie : New British Electric Kit : Introduction to Casting : First Fiesta Stox Meeting : Euro Champs at Lilford : Trade Review

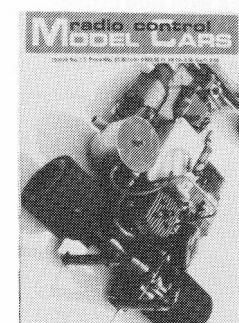

ISSUE 11 – Mardave Competition Special : Latest Lectricar : Futura III Track Report : Introducing PB8 & other Goodies : Building a Bo-Link : Designing the Demon : Vintage Electrics : Tips on Tyres.

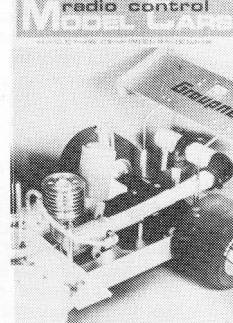

ISSUE 12 – World Championships at Geneva : Graupner R/C Car Built : Southern League : German GP : Painting Model Cars : Casting : Electric 1/12 Stox Draft Rules : Track Surfaces : Trade Review

ONLY Back Issues (a few No. 15 at 60p) as above. 50p each plus postage (1 copy 13½p : 2 – 17p 3 – 25p 4 or more Post Free)



L-D EDITORIAL & TECHNICAL SERVICES LTD

P.O. Box 30 HEMEL HEMPSTEAD Herts HP1 1NL

WELSH GRAND PRIX

AT WREXHAM

REPORT BY G. TAYLOR



With this meeting only five days after Monaco it was very good to see so many of the successful British Team at Wrexham joining the excellent entry of over eighty for Saturday and a hundred for Sunday. For this year's event the Hoseley Circuit had been considerably improved. Gone are the tyres that lined the edge of the track, in their place are a limited number of bot dots that are so esigned to persuade drivers to take the right line without causing any dangerous 'leaping' if they should be hit. Also new for 1980 was Wrexham's own lap timer. It was only finished a matter of weeks before the event but had been well tested in club events. It worked well over the weekend' the only problem being suspect batteries. With a shortage of experienced staff the able assistance of Muriel Russell and Eric White as Race Director was sought, to add to the services of Wrexham's Heather Golding. These three did a marvellous job.

Formula 1

Racing started on time and as it got warmer lap times began to drop. Steve and Chris White with Paul Pagdin all got 20 lap heats - Steve leaving the F/1 record at 20 in 5:5.3 some rain fell but by the semi-final the track was drying, Bob Errington, Draycott and Dave Feven getting through to the final.

The Handicap Finals brought some excellent racing, young David Tuck winning on the road in the 0-15% but placed 2nd on Handicap to Al Jones. John Farrington won on the road and on handicap in over 20% final.

The Handicap Finals brought some excellent racing, young David Tuck winning on the road in the 0-15% but placed 2nd on Handicap to Al Jones. John Darrington won on the road and on handicap in over 20% final.

The open final showed how exciting the sport can be with Keith Plested, Steve & Chris White and Paul Pagdin roaring off to make the running; Bob Errington leading the second group hard after the leaders. Showing how to do it Keith led for the first five minutes then let the 'young bucks' through into the lead. Steve & Chris then provided a wonderful display of driving, with the lead changing time and again until Steve got engine problem and dropped back to last place. Chris dropped back too during fuel stops with Paul and Keith in first and second places with Bob Errington coming up fast to challenge Chris for third place. Gremlins struck again - this time on Bob Errington's gears, leaving Paul Pagdin to take the flag.

1 Paul Pagdin	111 laps
2 Keith Plested	109
3 Fred Martin	108
4 Male Draycott	107
5 Chris White	103
6 Bob Errington	87
7 Dave Feven	58
1 Paul Pagdin	111 laps
8 Steve White	50 and FTD

Sports /GT

Sunday started sunny after heavy night rain but after three heats rain started again, but as it stopped and the track dried times improved and Bob Errington broke the circuit record with 20 laps in 5:2.4. Alas weather deteriorated and it became clear that no further heats could be run. This

Double winner at Wrexham Paul Pagdin. Does he get Professional Music Services to tune his engine . . . "Give me an A . . ."

Racing in progress at the GP with cars coming and going in a beautiful woodland setting.

All the winners with their trophies grouped by the rostrum . . . do I spot another Musician?



break was enlivened by Keith demonstrating the "treaded" Micro Racing tyres.

The selection of finalists on the heats that had been run threw up some interesting results. Peter Leslie in his first year of driving found himself in an open semi-final (Only missing the final by one lap). A very wet semi-final brought two "first time" finalists John Rowell and Keith Broadbent with Steve White. The Handicap Finals were also run in the wet. 0-15% was won by N. McLeod on the road and on handicap, the youngest competitor of the weekend Jeremy Taylor was second on the road but sixth on handicap. The over 20% final was a repeat performance by John Darrington - an excellent weekend for him though it made a mess of his handicap.

The Open Final started on a drying track that made tyre choice difficult. Paul Pagdin got it right and shot off in the lead -

never to be headed. Keith Plested slotted into the number two position and once again repeated the expert display by the PB drivers. Steve White with the PB/Greeno and brother Chris with the Serpent made a tremendous race for third place four laps down on Keith. They ended only 3.4 secs apart after a half hour race! Dave Ferndale, John Powell and Keith Broadbent by no means disgraced themselves in the last three places against such talent.

1 Paul Pagdin	95 laps
2 Keith Plested	91
3 Steve White	87
4 Chris White	87
5 Bob Errington	82 & FTD
6 Dave Ferndale	73
7 John Powell	71
8 Keith Broadbent	63



1/8 SOUTHERN LEAGUE

THE new purpose-built circuit at Aldershot was the scene on Sunday 11th May for the opening round of the 1980 Southern series. The use of a brand new circuit and the appearance of two additional teams (Wessex and Torbay) this year caused some interest.

By way of explanation, the League events are for teams of 6 drivers driving Sports/GT cars and each of the 30 heats at each round has a car from every team ie. 10 car races this year.

The track width at Aldershot is comparatively limited which was highlighted by the number of cars in each race. The problem of accommodation on the start grid was overcome by the adoption of the old style 'Le Mans' echelon start and this seemed to work quite well - although those at the back had a lot of ground to make up. Excursions into the infield were frequent and this meant that the dust resulting from the long dry period was carried onto the track with resulting grip

problems. Once the grass has grown things will be a great deal better from this point of view.

The racing was, as always, extremely hard fought and the new teams performed well under the competitive conditions, with Torbay finishing 3rd overall in their first major outing. The results of this Aldershot round were:-

*started with handicap penalty of 20 points

	points
1st Bournemouth	*218
2nd Southampton	211
3rd Torbay	206
4th London	178
5th Wessex	163
6th Aldershot	160
7th=Exmouth	158
7th=Mendip	158
9th Taunton	130

The remaining team (Northavon) did not compete at this round.

General Comments

An excellent weekend with no aggro despite eight car heats, rain and finals in the water.

PB cars dominated proceedings yet again in various forms including Steve's Green-Special. The only "springer in the market" being Chris White's Serpent which matched the PBs for speed but not consistency. OS engine appeared quickest at the top end but seemed slower out of corners than the OPS cars. This could be carburation or tuning making the differ-

ence. K & Bs were hardly in evidence at all, though one K & B powered car was seen out powering the OS cars in practice. One or two Super Tigres were also running.

The suspension car did not appear at Wrexham which was disappointing. PB Lotus 80 was the Formula 1 body to have, although the British team members had the latest Lotus 80 which amounts to a Lotus 80 without a front wing (well almost!). Shadow, Kroll, Cheetah and Toj all appeared in Sports/GT none demonstrating any particular superiority over the others.

2 NEW 1/12 SCALE CARS FROM PARMA

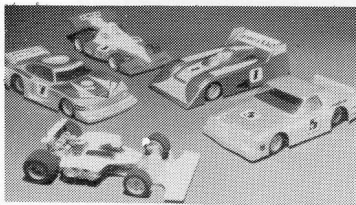

PARMA TIGER
Our Professional Racing Car

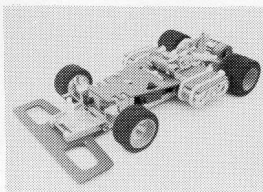

GROUP 12
A Class never to become obsolete

NEW ITEMS ...

Graphite Axles and Chassis Plates, Nylon Chassis Screws, New Paint Colours, Special Diffs., New Bodies Lotus Europa GP5, Mirage M10, New Can Am Lola TT30, Chevron B36, Porsche 908 and Speedster.

If your local shop doesn't carry our parts please send us his address and send 50p for Tool Box Stickers and latest R/C and Slot Catalogues.



parma
INTERNATIONAL INC.

13927 PROGRESS PARKWAY
NORTH ROYALTON, OHIO 44133 USA

Keith Plested, Managing Director of P. B. Products, Havant, says:
"MacGregor & P. B. Products decided to combine their talents in order to develop a new two channel system for car racing.

The results were most impressive as it allowed an improved driving technique giving a distinct advantage under racing conditions."

A WINNING COMBINATION

The MacGregor MR 1222 ASN/2S special incorporating the new MR 12T high torque servo and the International from P.B. Products.



Designed for the improved sensitivity and power necessary for controlling high performance models.

Available in all good model shops now.



MacGregor
Radio Control

Canal Estate, Langley, Slough, Berkshire SL3 6EQ
Telephone: Slough 42251

STOP PRESS!

To All Retailers: MacGregor are now distributors for P.B. Products

Join SMAE—the modellers safeguard Tel. 0272 48869

DUTCH GRAND PRIX

REPORT BY STEVE WHITE

The circuit at Utrecht is purpose built and has held European championships in the past. Surface is quite smooth but dusty: the shape is similar to a number of British tracks – a mixture of fast straights and sweeping bends. It requires a lot of driving skill to get the right lines fast and consistently. No less than fifteen British drivers made the trip, all crossing from Harwich on the overnight ferry to the Hook, where we were greeted with driving rain. Most of the party by sundry means got to Utrecht by about 9 a.m. when the rain had stopped but left a soaking track.

The meeting was due to start at 10 o'clock but with all the rain nobody was very enthusiastic about practice and most people set about making sure that radio gear and air filters were waterproof. The track gradually dried and first heats began. A number of drivers decided not to drive in their first heat as it was still wet, so why risk damage to the car, when it might soon be continuing in the dry. First round produced only eleven laps for the 5 min. After the second round this went up to 15 laps, and coming to the end of the last round the three fastest times were British: Phil Greeno, Phil Booth and Steve White who looked to be going straight into the final, but brother Chris White put up a good time to oust Steve into the semi final, incidentally, driving a last year's Serpent which seems an easier car to drive than the 1980 car driven by the Serpent Team drivers. The next fourteen drivers were split into seven-car semi-finals. Mark Plested was unlucky enough to miss the semis by tenths of a second. Two very creditable performances came from John Milner and M. Lammiman of the Professional Music Services Team, competing in their first overseas event – who came 23rd and 24th respectively, actually beating F/1 European champion Peter Bervoets who looked very unhappy with the new Serpent.

The semis proved to be mixture of good and bad for the British drivers. Steve White suffered a broken Rx wire when leading to let Ronnie Ton through with Dave Preston following him over the line. Second semi proved a repeat of the first with Debbie Preston pulling out with a broken servo while leading. Keith Plested who was second then carried on to win with Denny Tassaux second. Final com-

prised five GB drivers, one Dutchman and one Belgian.

Finals presented some problems with five drivers from GB in sorting out pit crews. Phil Greeno led from the start, eventually winning by three laps, the main battle being for second place with Phil Booth just failing to catch Ronnie Ton. A good day for GB with Phil Greeno also taking FTD.

Sunday dawned dry but foggy, then cleared to leave a sunny day. Misfortune soon struck Paul Pagdin who had cured his Saturday problem, but in cutting a corner his front bumper dug in and snapped the chassis! No more practice for Paul until he re-built the car!

First round of heats left Phil Greeno again in the lead with Ronnie Ton and Phil Booth close behind. By the end of the heats Ronnie Ton had taken FTD, with all three drivers on 17 laps, which had only been achieved once before. The only time when these three looked like being upset was when Chris White was given 17 laps which was obviously wrong. The Race Director was adamant but after prolonged discussion Chris convinced him that he was not entitled to that figure having missed the start – a very sporting gesture which I wonder if it was appreciated.

Again the semis had four British drivers (plus Phil Green and Phil Booth already in the finals). A twenty minute downpour just before the semi finals started caused problems with tyre selection. Steve White and Debbie Preston chose the usual grooved tyres hoping that the track would dry out enough as the race went on. Peter Bervoets chose capped tyres which suited the really wet surface. Peter built up an early lead with his capped tyres proving the better, but as the track dried out Steve White who had kept within a lap gradually caught up and passed him with a lap to spare. Debbie alas had problems with her car. Track was almost dry by the start of the second semi so tyre choice was less important for Keith Plested, Dave Preston and Chris White, the Britons involved. Both Chris and Keith had problems, whilst well placed to allow Dave Preston to win easily. So we had four British drivers in the final, with three Dutchmen making up the number all driving Serpents.

The final again started with Phil Greeno leading from Ronnie Ton and Peter Bervoets. Both Dave Preston and Phil Booth suffered chunked tyres putting them out

of the running for the lead. Steve White made a mess of the first corner to find himself at the back of the field gradually worked back to catch and pass Peter Bervoets for third place. Phil Greeno again drove a perfect race to win by a lap from Ronnie Ton.

Phil Greeno had pulled off a remarkable double considering the level of competition and along with the other British drivers had reversed the results at the previous Utrecht Grand Prix when the Dutch Serpent dominated.

Sports/GT

(72 recorded entries)

1 Phil Greeno	GB 96
2 Ron Ton	NL 95
3 Steve White	GB 94
4 Peter Bervoets	NL 92
5 Phil Booth	GB 86
6 D. Preston	GB 83
7 E. Ijzerman	NL 65
8 J. Goosemans	B 56
9 Keith Plested	GB 55
10 Chr. Royet	F 53

Other GB: Chris White 11; D. Preston 14; Walt Bailey 24; Ted Longshaw 26; Mark Plested 30; J. Milne 31; P. Pagdin 35; M. Lammiman 49; R. Wylie 54; N. McCloud 61.

Formula

(58 recorded entries)

1 Phil Greeno	GB 89
2 Ron Ton	NL 86
3 Phil Booth	GB 86
4 Dennis Tassaux	B 83
5 Dave Preston	GB 79
6 Keith Plested	GB 66
7 C. White	GB 65
8 J. Goosemans	B 57
9 G. Thiran	B 53
10 J. Burger	NL 53

Other GB: T. Longshaw 12; Walt Bailey 14; D. Preston 16; S. White 15; Mark Plested 19; J. Milne 21; M. Lammiman 22; R. Wylie 40; N. McCloud 44; P. Pagdin 47.

Comment on the meeting. As usual organisation was excellent – only problem being lack of crowd control, with cars flying off the circuit into the crowd who stood all round the edge of the track with no barrier or fence as a safety measure. The notorious radio problems connected with Utrecht seemed to have been cured by removing the metal rostrum and building a brick and mortar replacement on the top of race control. Everybody was made most welcome and the journey proved very worthwhile.

RADIO STOCK CAR ASSOCIATION

FIXTURE LIST 1980 (2nd part)

AUGUST

3rd Nottingham: Open Event
10th Keighley: Open Event – Steel & Walker Trophies 10.30 a.m.
17th Nottingham: Open Event; Keighley: Open Event
24th S.R.C.C.: Open Event – Worthing Fiesta International
31st Chessington: Open Event – Series Championship R.4

September

7th Coventry: Open Event – Series Championship R.5
14th Leicester: Open Event
21st Craven: Open Event – Series Championship R.6 Nottingham: Open Event; Hayward Heath: Open Event; Pendle: Open Event
28th Chessington: Open Event – World Final

October

4 11th Open Event – Pontins

5th Coventry: Open Event
12th Nottingham: Open Event
26th Nottingham: Open Event – Series Championship R.7

November

2nd Coventry: Open Event; Leicester: Open Event
9th Chessington: Open Event – Hayward Heath Open Event
16th Coventry: Open Event
30th Chessington: Open Event

December

7th Open Event Annual General Meeting
14th Chessington Open Event – Team Stockcar Racing
28th Leicester: Open Event

1981

January
4th Keighley: Open Event

JOIN THE CAMBRIA TEAM

Choice of either Saab Turbo or Lamborghini Countach 1/12 scale electric racing car kits. Both these models use the same chassis with the Cambria Front Wheel Drive system for superior all round performance with none of the problems associated with rear wheel drive slip and spin. Kits contain all the parts required to assemble the models except for the 2-function radio equipment. Backed by a spare parts service second to none, full range of racing accessories, various tyre compounds and alternative body styles (Ferrari and Porsche shown).

NEW ADDITIONS TO OUR CAR ACCESSORIES

Cambria O.G. Differential Unit. Glass Fibre Chassis. 4S Speed Controller. Narrow Front Wheels and Tyres.

ASK YOUR MODEL SHOP FOR DETAILS OF THESE AND ALL OUR OTHER ACCESSORIES.

KIT PRICE including VAT£36.95

Nicad Battery Pack.....£16.00

SAAB

PORSCHE GT



LAMBORGHINI

FERRARI GT

Distributed in the U.K. by Cambria and Ripmax

All export enquiries to the manufacturers: Mid Wales Model Manufacturers L.td., High Street, Llanidloes, Powys. SY18 60A

HOWES

9-10 BROAD STREET, OXFORD
OX1 3AJ. TELEPHONE: (0865)
42407

ASSOCIATED ELECTRICS, INC. 1/12

3010	RC12E 6 cell car kit complete except radio. Kit includes clear lexan body ready for painting	£59.95	3424-13	Pinion gear, steel, w/set screw, 13 tooth	£2.13	3505	Motor connector	£8.16
3180	Driver, white unpainted	71p	3424-14	Pinion gear, steel, w/set screw, 14 tooth	£2.13	3510	Re wound 05 motor (33t of 22GA), lacq'd, balanced, w/conn	£10.65
3181	Driver clear lexan	71p	3416-44	Spur gear, nylon, 44 tooth, w/mtg screws	71p	3511	REEDY-ASSOCIATED Modified 05 motor, re-wound with larger wire, epoxied, balanced, commutator trued, and two precision ball bearings	£29.99
3182	Wing, clear lexan, w/mtg hdwe	£1.42	3416-46	Spur gear, nylon, 46 tooth, w/mtg screws	71p	3610	Rear rims, w/mtg screws Pair.	£2.48
3200	Front suspension kit; includes suspension arms, kingpins, steering blocks, stub axles, and mtg hdwe	£5.68	3416-48	Spur gear, nylon, 48 tooth, w/mtg screws	71p	3611	Rear tire donuts. Pair	£2.13
3210	Suspension arms, w/mtg screws	£2.13	3417	Oilite bushings for rear axle, 1/2" I.D.	£1.06	3613	Rear wheel hub. Pair	£3.55
3211	Steering blocks	£1.42	3418	Nylon bearing adapters, 3/8" I.D. x 5/8" O.D.	71p	3615	5-40 x 1/2" allen cap screws pkg 6	71p
3212	Kingpins w/mtg clips	£1.06	3215	8-32 x 1/2" panhead screws pkg 12	71p	3616	10-32 x 1/2" allen set screws w/wrench pkg 6	71p
3213	Stub axle, w/mtg clips	£1.42	3419	Motor mtg screws (4-40 allen cap w/washers)	36p	3650	Front rims, w/bushings pair	£2.48
3214	"E" clips pkg 10	71p	3420	Wing tube collar screws (5-40 x 1/2" allen cap) pkg 6	71p	3651	Front tire donuts, medium pair	£2.13
3215	8-32 x 1/2" panhead screws pkg 12	71p	3421	Gear mtg screws (5-40 x 3/16" shoulder screws) pkg 6	71p	3651-S	Front tire donuts, soft (give more steering) pair	£2.13
3216	1/8" I.D. axle washers pkg 12	71p	3423	Wing tube brace	71p	3655	Ball bearings for front wheels, pkg 4, will also fit motor; 1/8" I.D. x 5/16" O.D. flanged	£9.99
3310	Chassis plate, fibreglass, stock	£4.97	897	Ball bearings, 1/4" I.D. x 3/8" O.D. pkg 2	£7.06	3706	Radio tray, lightweight, designed for ultra mini servo such as Futaba 30M. Resistor can be mounted on top, underneath, or in notch provided. No servo holes. For experienced builders, made of .062" f'glass	£3.55
3311	Chassis plate, lightened and counterbored for flat head screws. "Keyhole" cutout gives maximum flex	£8.52	2222	Ball bearings, 1/4" I.D. x 5/8" O.D. pkg 2	£3.46	3710	Radio tray, stock, no servo holes	£2.13
3312	Chassis plate, as above, but with "triangular" rear lightening hole. Flex same as stock plate	£8.52	3425	Spur gear, 44 tooth (for differential)	£1.06	3719	Battery mounting cup	71p
3320	Front body mounts, w/hdwe	71p	3426	Spur gear, 46 tooth (for differential)	£1.06	3722	Rubber grommet pkg 6	36p
3321	Front body mounts, spacers, w/hdwe	35p	3427	Spur gear, 48 tooth (for differential)	£1.06	3723	8 thin washers pkg 12	71p
2207	Hood pins, pkg 6	35p	3430	Differential, complete w/ special tube axle, hub, rings, carrier, gear and balls, Belleville washers, shims, and locknut. Unit replaces standard axle and right-hand wheel hub. Uses standard wheels	£10.65	3724	Front tray mount, w/hdwe	53p
3322	8-32 x 1/4" panhead screws pkg 6	71p	3431	Rear axle for differential, tubular alloy steel; with differential hub, stud, shims, and Belleville	£5.68	3711	Throttle control resistor	£5.32
3323	8 thick washers for body mounts pkg 12	71p	3432	Ball set for differential pkg 16	71p	3712	Throttle control wiper	88p
3324	Aluminium flat head screws, 8-32 x 1/4" pkg 16	£1.42	3433	Drive ring set; 2 hardened and ground rings and one aluminium ring carrier avail.	£3.55	3713	Throttle control mtg bracket	71p
3325	Aluminium flat head screws, 8-32 x 1/4" pkg 6	£1.06	3434	Thrust ball bearing, 1/2" I.D. x 9/16" O.D., for differential (one req.) or as rear thrust for non-diff set-up (2 req.)	£1.77	3726	Charging plug	88p
3400	Rear end kit; includes axle/motor mounts, bearing adapters, bushings, motor plate, axle, wing tubes, brace, wing tube collars, and mtg hdwe	£6.39	3435	Bellevalle washer and shim set	36p	3731	18 gauge stranded, superflex wire, high temperature silicon insulation. 3 ft of orange	£1.77
3410	Rear axle/motor mounts, w/bearing adapter	£2.48	3450	Rear axle, non-diff., tubular alloy steel	£2.84	3740	Battery connector, 3 pin, pair	£1.06
3411	Camlock motor plate	71p	3500	05 motor, ROAR/BRCA legal production and stock/standard class, lacquered		3752	Can't read this line — — — Tie rod and linkage kit	£1.77
3412	Rear axle	£1.42				3753	8-32 x 3/8" panhead screws pkg 12	71p
3413	Rear tubes	71p				3754	8-32 x 5/8" panhead screws pkg 12	71p
3414	Wing tube collars, nylon	71p				3755	New moulded 2-piece servo saver, w/hdwe	£1.77

POSTAGE & PACKING 50p on orders under £5.00

of OXFORD



MAIDENHEAD OPEN 80

REPORT BY LES PIPE

MAIDENHEAD 80 was held at the same venue as last year, Maidenhead Leisure Centre, the third National meeting of the year. Again there was an excellent turn out of enthusiasts, along with a large number of entrants who did not get their entries in early enough to be accepted. The popularity of all National meetings is getting so great that unless entries are submitted very early, there is no chance of getting in.

The meeting proved to be very controversial in many ways. The much rumoured appearance of the electronic motor testing device materialised in all its splendour. (It wouldn't have looked out of place in Star Wars!) It arrived amidst heckles of 'unnecessary, unreliable, not accurate enough, biased, unpractical, too complicated, best thing since sliced bread, a fair test, definitely necessary. etc.' Amidst a lot of aggravation, the organisers remained calm. The unenviable job of scrutineering the motors was left to Derek Scotland assisted by Richard Gammon, Derek supplying the equipment. I had a chance to talk to Derek during the day about the equipment and to put it in a

nutshell, a lot of time and effort had been put into obtaining the necessary data to make this form of testing a possibility. Whether in the long term it will prove to be effective only time, more effort coupled with understanding, and patience on behalf of the racing fraternity, will remain to be seen. As to how all this affected the drivers on the day, my only comment is that the same names and faces (with the exception of one or two as always) were present in the final!

Since the beginning of 1/12th car racing, motors have been the thorn in the lion's paw. Maybe this method could start to give even chances for everyone, or maybe not? Is there more to getting a car to go quickly than just the motor? This saga will undoubtedly be continued time and time again after every National meeting. The advantages of obtaining a motor which will propel your car faster than your opponent's is obvious from the top drivers right down to the humble beginner. The question of whether this performance should be obtained at any price is what has effectively triggered off this situation we find ourselves in. There seems to be an ever increasing flood of tuned motors

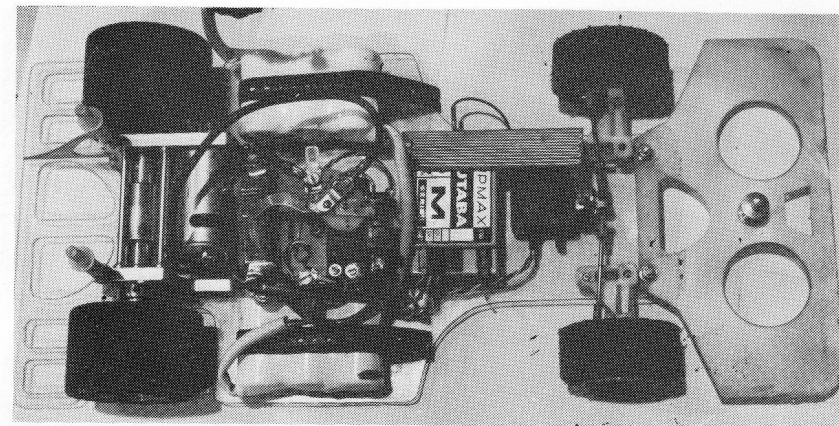

Heading: Circuit, rostrum and some of the pits.

appearing from below the legal maximum to as high as a reputed £47 so far! I think it is the duty of all racers actively involved in club as well as national meetings to consider the far reaching possibilities of the situation. To highlight but a few, with most of the new breed of tuned motors, other than increased speed comes increased running times (as much as 10 mins) which knocks the idea of 8 minute races to sort out special motors on the head.

Most of the tuned Astros, Igarashies, Parmas and M.R.P.s have been tuned for efficiency as well as out and out speed. With the enclosed motor can of the previously mentioned motors, it is impossible to see increased wire diameter, trued comm., balancing holes in the armature, brush springing or epoxying to name but a

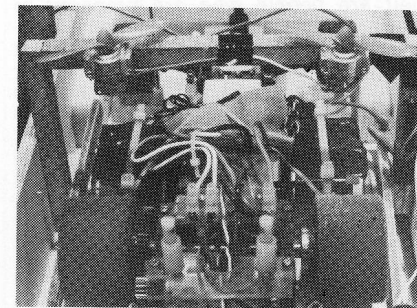

Top: Neal Francis' car considerably lightened. Note also printed circuit aerial and o/d diff.

Peter Sparling's propellers — a novel cooling device at fast charge time.

That testing apparatus! The sausage roll is NOT mandatory.

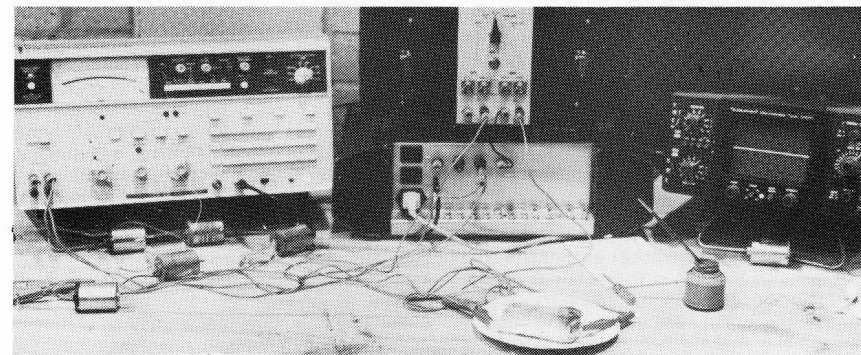

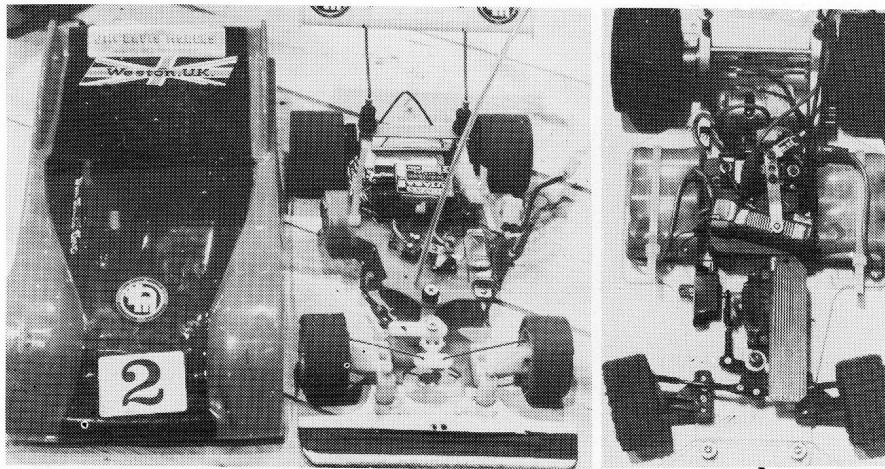

few. The final straw must be that whilst their are people who are prepared to spend small fortunes on obtaining the latest in motor technology, the best the rest of us can do is follow suit (food for thought!) The lead in testing motors which was set at this meeting, may not have been all things to all people, but they did try. Full marks must go to the organisers for that. It was a real effort to provide a light at the end of a very, very dark tunnel. John Chamberlain, Race Director for the day said at the end of the meeting that it was the club's aim to start 'the ball rolling', and it certainly has!

Whatever motor type we settle on for our standard class racing, all the tolerances from new to old worn motors must be found, and an accurate method of testing must be found. All this must be translatable to the average club racer or the situation which reared its ugly head at Maidenhead will happen again . . . one of lack of understanding breeding contempt for the scrutineers and their methods. From past indications the three tier class racing used in the States may not be far away. Whether this method will be more effective in pleasing all of the people all of the time will remain to be seen. I can only hope that whatever happens is for the good of the majority of the racers in the sport, not the minority.

After that rather lengthy opening to the race report, let's get on with the details of the day's racing. My rather early arrival at Maidenhead did not surprise the organisers. I thought I might still catch them laying the track out, but after many hours burning the midnight oil everything was

Jim Davis Jnr's lightweight Associated. Note simple resistor type speed controller.

Bill Maisey's car; again with simple Associated resistor speed control. Old geared diff.

prepared and ready for action. It makes all the difference having keen people around when there is work to be done.

A lot of people were surprised with the decision to run in an anti-clockwise direction. It is quite a common direction for 1/8th scale racers doing F.1. meetings, and also stock car racers, but 1/12th scale electric racers across most of the country seem to follow the practise of running clockwise. Ally Pally always run their Battersea Park meetings anti-clockwise and they don't get any complaints there. I think this is another problem that the B.R.C.A. could resolve, so that we can have some kind of conformity at all National Meetings.

The first races as always proved interesting to everyone. The first contestants were asked for their opinion of the floor surface . . . very slippery was the reply! After the first six races a distinct silicone line could be faintly detected around the whole circuit. As grip started to come, so did the high scores. The lap scores started off at around the sixteen mark, but were soon climbing steadily into the twenties. The races were of six minutes duration leading to seven minute finals. Neal Francis, again on top form, proved that he can still take the fastest time of the day without too much trouble with a blistering 22 laps. With the absence of Phil Greeno or Walt Bailey to chase him the gauntlet was picked up by Bill Maisey, Nick Adams, John Chamberlain and Jim Davis Jnr. The

Main Final Results	Kit	Scratch built	Nicads	Chassis Material	Differential	Motor type	Front Tyre	Rear Tyre	Speed Controller	Body Shell	Radio Gear	Special feature
1 Neal Francis		Yes	Saft	Lexan	Own Geared	Mabushi	Mardave Rubber	Armaflex	Associated (Resistor)	McClaren M20 (Lexan)	Futaba M twin stick	Associated front blocks. Live stub axles. Push on rear tyres.
2 Jim Davis Jnr. lightweight	Associated		Saft	Fibre glass	Schumacher	Mabushi	Mardave Rubber	Armaflex	Associated resistor	Ferrari	Futaba M twin stick	
3 Nick Adams	Gemini		Sanyo	Fibre glass	Greeno/Schumacher	Parma Renault	Lectricat med. rubber	Parma 'C' foam rubbers	Reverse Demon	Prophet	Sanwa	
4 Tom Morgan		Yes	Saft	Lexan	Own Geared	Mabushi	Mardave and Armaflex	Armaflex	Associated (resistor)	McClaren M20	Futaba M twin stick	Associated steering push on front & rear tyres
5 John Chamberlain	Gemini		Saft	Fibre glass	Greeno/Schumacher	Mabushi	Raydio medium rubber	Raydio medium neoprene	Reverse Demon	Prophet	McGregor J.R. F.M.	
6 Russell Buckner	Gemini		Saft	Fibre glass	Greeno/Schumacher	Mabushi	Raydio med. hard rubber	Raydio soft-neo	Reverse Demon	Prophet	J.R. McGregor	
7 Geoff Peters	Gemini		Sanyo	Fibre glass	Greeno/Schumacher	Parma Renault	Raydio Soft neoprene	Raydio Medium Neop	Reverse Demon	Prophet	Futaba M twin stick	
8 Andy Dobson	Gemini		Saft	Fibre glass	Greeno/Schumacher	Mabushi	Raydio Neo	Raydio Neo	Smooth tronic	Prophet	McGregor A.M.	
9 Bill Maisey		Yes	Saft	Lexan	Own Geared	Mabushi	Armaflex	Armaflex	Associated speed resistor	Prophet	Futaba M twin stick	Associated front steering. Push on rear tyres

qualifiers were to determine the finalists. Five six minute heats were run, and the fastest nine times of the day were put into the main final. Two handicap finals were run as is becoming the norm in the National Meetings. There were some complaints about the omission of semi-finals.

The Maidenhead club were really sticking their necks out for a lot of moaning! When the moaning was forgotten the race organisation was superb, and could not be faulted. With everyone having five heats of six minutes duration the racing could well have dragged on, but the qualifying heats went by without a hitch. The fast turn around of heats was the order of the day, all controlled by a PET computer programme written by Steve Brown (or Itomark as his enterprise is now called). Scrutineering was done while the drivers were doing the mandatory two heats marshalling after their heat. This meant there were no long queues. This is becoming the standard practice and one well worth considering by all organisers of National meetings, to help keep the constant flow of the meeting going.

After about eight hours racing we had our nine finalists consisting of Nick Adams, Neal Francis, Jim Davis, Tom Morgan, John Chamberlain, Russ Buckner, Geoff Peters, Andy Dobson and Bill Maisey. Again National Champion, Neal Francis got the break, from the start, pulling a good 4 yds clear by the end of the very generous straight, but straight line speed was not his greatest asset as

demonstrated on many occasions. It was the power linked to the overall car control and stability through the corners which again proved to be too much for the opposition, despite some enterprising driving by Jim Davis and Nick Adams. It was not as complete a domination as it may sound, because halfway through the seven minute final, Neal's car received a glancing blow from a back marker which resulted in the side of the body shell being wedged up over the battery pack, upsetting the delicate balance of the car more than at first thought possible. Fortunately for Neal, after contact with one of his fellow finalists, the shell cleared itself from the precarious position and he was able to regain full control, drive in his accustomed manner and run out a worthy winner.

A notable point at this meeting was the very high standard of body shell preparation. It was interesting to note that although there was no Concours class, people are beginning to take a lot of trouble and pride in their bodysells. A favourable swing to the very smart 'Prophet' shell was noticeable. There was also a very big swing to the number of Phil Greeno's 'Gemini' kit car, which people seem to be finding very competitive. The electronic speed controller is also making a big impact, being used in more and more cars. Nick Adams Demon (apologies to Nick for photograph in the last edition, when his controller was NOT included as stated) now featuring reverse, was probably most in evidence. I can thoroughly

recommend this, having used one for some time now.

Around the pits I spied a lot of novel methods for cooling down battery packs. One particularly novel idea was a small motor with props attached hung on gannies suspended over the car. Battery care seemed to be the order of the day. Many people have invested in liquid crystal voltmeters. This seems a very worthwhile investment after reading Gene Hastings excellent article on batteries in the last edition of Model Cars. A D.I.Y. version is obtainable from T. K. Electronics for the electronically minded (see photo,) For further battery information look out for an article in this magazine from Alan Greenfield of Western U.K. Ltd. (the Saft cell agents).

The final episode in what must be an 'historical' meeting was a very unfortunate incident. Some time during the day the operators on the motor testing equipment changed from time to time. Regrettably some errors crept in. When the finalists' cars were scrutineered after the final,

some motors which had previously been passed were found to be illegal. The organisers mutually decided after lengthy discussion that the results of the final should stand. A rather black note on which to end the meeting, but I feel (and I know a lot agree with me) that full credit must go to the Maidenhead Club for trying this necessary experiment if car racing is to continue to grow in the 80's.

OTHER RESULTS

0-15 handicap final	0-20 handicap final
1. S. Durrant.	1. S. Tilley.
2. J. Glenn.	2. G. Davies.
3. S. Waterhouse.	3. N. Walsham.
4. R. Bourden.	4. S. Grove.
5. D. Tongue.	5. P. Sturdy.
6. K. Phillips.	6. K. Rigby.
7. P. Stones.	7. B. Simmons.
8. A. Hastings.	8. A. Stephenson.

TEAM RESULTS

1. Jim Davis Models.
2. Ally Pally.
3. Team Gemini.

FTD

Neal Francis.

CLUB & TRACK REVIEW

films and so on. Indeed a film of the Stox Champs last season at Keighley has just been shown. Cine films of r/c cars are much harder to make than one might think (I have thrown away many many feet of near and not so near misses!) so congratulations to whoever made it! New members very welcome at subscriptions of £3.75 adults, £2.75 juniors and £8.00 for a family (three members - wise limitation, some families are a club in themselves!)

techniques which are exhibited by some of our drivers. The public and local council have shown a considerable interest in this fast growing hobby (our policy of audience participation has helped a great deal) and we hope that this will eventually lead to construction of a 1/8th scale track as a public amenity. The club meets every Sunday although the venue varies according to our social commitments. Further details from the secretary."

A splendid example of the very best way of starting and running a club . . . please the people **and** the council and you shall have both circus and bread.!

The Halfmoon Model Engineering Club

Secretary: G. Matthews
99 Elm Avenue
Caddington (Tel: Luton 35689)
Luton, Beds.

Just a short notice of the Halfmoon M.E.C. which meets on Sunday afternoons for stock car and 1/12th electric car racing at The Halfmoon, Pepperstock, Luton, starting at 2.30 p.m., and on Monday evenings socially at the same venue. Currently the club are looking for suitable accommodation to race 1/12th scale cars **indoors**, which looks as though this hardy group normally race everything outdoors! Any help in this direction welcome as indeed are new members. Contact sec. as above.

Andy Dobson's Gemini — five of them made the final!

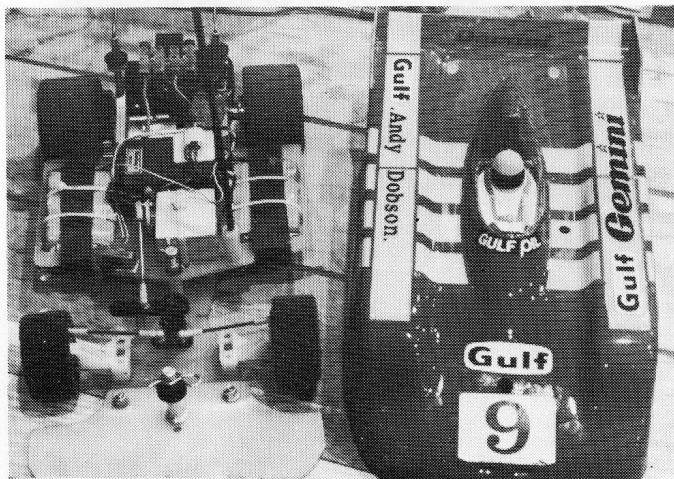

Transmitter pound and where do those sponsors all come from?



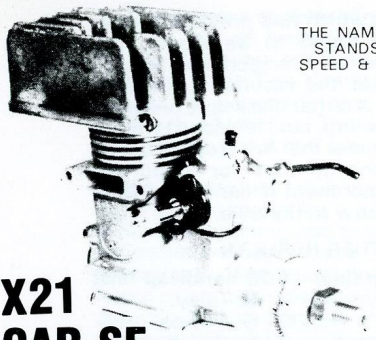

THE NAME THAT STANDS FOR SPEED & POWER

SUPER Tigre

Since its arrival last year the Super Tigre X21 has been the pacesetter for other manufacturers to follow. A rugged construction able to cope with the arduous conditions of competitive car racing. Just compare the specification with the opposition. An ABC piston assembly with light-weight piston, bronze bushed bigend conrod, heavy duty 12mm dia. crankshaft running in double ball bearings, specially diecast crankcase not a conversion from aircraft motor, large bore carburettor with the superb idling of all MAG series carburettors, deep finned heat sink, squish band head. BHP .75 at 25,000 rpm, weight 9 1/4 oz. Used by most of Europe's leading drivers.

Race-proven to be one of the most reliable motors produced so far. It's the motor that finishes that counts. The long life of all Super Tigres together with easy availability of any spare part for that eventual day when its run "over the hill" makes this motor the popular choice. No Labour Charges on ST repairs: you only pay for parts and postage.

Don't forget TALISMAN 2-channel FM Systems are Britain's Best Buy for the serious car enthusiast. SAE will provide details.

X21 CAR SE
£40.99 complete with heatsink

SUPER TIGRE ENGINES are distributed by MicroMold & Tigre Engines.

T SUPER TIGRE MOTORS ARE AVAILABLE FROM THE VERY BEST MODEL SHOPS

TIGRE ENGINES

Visitors by Appointment
S.A.E. with enquiries please

97 Tudor Avenue, Watford, Herts. Phone Watford 42859



UNITROL ELECTRONIC SPEED CONTROL

VERY FAST RESPONSE
PROPORTIONAL FORWARDS & REVERSE
PROPORTIONAL (DEAD STICK) BRAKES
6 VOLT REGULATED OUT-PUT TO RADIO & SERVOS
OUT-PUT 14 AMPS (25 AMPS PEAK)
ONLY 85gm & 52mm x 34mm x 32mm

Compatible with the majority of positive pulse systems with simple adjustments, e.g. Futaba, MacGregor, Sanwa, Accoms, Skyleader, etc. Available from most good model shops or direct from suppliers.

RETAIL PRICE £34.00 inc. VAT (Trade Enquiries Welcome)

UNICORN ELECTRONICS

11A BROOMFIELD ROAD,
EARLSDON, COVENTRY. Tel (0203) 78641



PHIL GREENO

MODELS LIMITED

9 Village Way East, Rayners Lane, Harrow, Middx. Tel. 01-8667770

SPECIAL ITEMS

* NEW Wing Wire Adjusters (1/8)	£2.50
* NEW MRP Front Tyres pr.	£4.25
* NEW Paper Element Air Filter with rubber base	£2.25
* NEW Tuned Racing Silencer	£16.95
* NEW Lexan Paint 8 colours	£1.00
* NEW Metallics 5 colours	£1.10
* NEW Fluorescent 5 colours	£1.00
* NEW GRP NARROW Chassis	£8.50
* NEW GRP Standard Chassis	£9.05
* NEW GRP WIDE Radio Plate	£6.95
GRP Standard Plate	£3.14

Veco/McCoy parts always in stock

Brake Adjuster	£4.20
Roll Bar	£2.92
Alum. Body Post	£1.59
Comp. Clutch Nut (P.B.)	£2.75
Flip Top Tank	£14.37
Pumper 61 Carb.	£9.60
Perry Pumper 61 Carb. (tuned to 12mm)	£10.60

ENGINES

NEW OS 21 FSR Car	£52.59
OPS 21 Car	£54.00
ST X21 Car	£51.40
K & B 21 R/C	£50.58
Veco 19 R/C	£29.23
New Veco 21 R/C	£31.89
Irvine 20 R/C	£38.28

ACCESS! BARCLAYCARD! HOBBYCARD! H.P. TERMS PLUS FAST MAIL ORDER

S.G. Air Filter	£2.07
P.B. Air Filter	£2.92
Delta Fuel Filters	£1.59
Delta Output Arm	£1.00
Assoc. Fliptop Lid	£3.99
Field Charger	£8.46
Glowpack	£16.98

R.C. CARS

P.B. International No. 9	£127.26
P.B. International No. 8	£95.31
P.B. International No. 7	£70.39
P.B. International No. 6	£79.87
P.B. Expert Comp	£65.36
S.G. Comp	£71.05
S.G. Futura III	£76.68
Associated RC200	£127.74
Associated RC1	£85.14
Serpent III	£80.71
Delta 780 Super J	£111.82
Mardave Formula	£25.29
Mardave Saloon	£25.29
Mardave Stockcar	£25.29
Ke'jon Stock Car	£34.75

Machined Engine Blocks	pr. £2.07
Machined Rear Power Pod	£8.89
Machined aluminium Front Beam Mk 2, wider front track	£14.85
NEW Ballraced Disc Brake complete with fibre disc machined steel shoes	£15.92
NEW Ballraced Disc Brake complete with fibre disc machined steel shoes, assembly with Brake Adjuster	£19.11
Ditto DOUBLE ballraced	£20.18
A.M.P.S. Differential Unit with bearing blocks and disc unit to fit P.B. International	£57.45
Racing Special	£60.65
NEW Mini Diffs to fit PB Int. RC200, Serpent from PB Diff.	£35.67
	£36.21

PLUS A large stock of R.C. car spares always in stock including P.B. Associated, S.G., etc.

SPECIAL OFFER:
SG Futura III Factory Assembled with Differential £99.50

Plus parts available separately
1/12 Diffs in stock

Jerobee r/c electric Lectricar with prop. speed control	£59.58
	£47.78

Also large stock of BO-LINK, JOMAC, JEROBEE, ELECTRO CRAFT 1/12th ELECTRIC CAR KITS AND ACCESSORIES
* NEW Full Range of TAMIYA KITS

REWORKED MOTORS	
Inc. Pumper Carb.	
O.P.S. 21	£75.00
ST.X21	£75.00
K & B 21 ("McCoy-ed")	£75.00

All prices correct at time of going to press but subject to alteration.

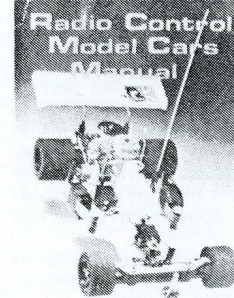

Radio Control Model Cars Manual

128-pages A/5 size (8 1/2 x 5 1/2 ins) Drawn on Card Cover with Photo-pics. Contains: Articles from the current year's *Radio Control Model Cars* covering such items as Tyres, numerous kit reviews and building guidance, World Champs in Geneva, Painting Car Bodies, Buggies, Scratch built cars. Plus articles from *Model Mechanics* on R/C Car Modelling for the newcomer, Stock Cars, Electrics. Digests from American model press on Hotting Up an Engine, Building Chicken Hopper Fuel Tanks. Plus for Electric Racers Highlights of famous *Ally Pally Newsletter* from Nick Adams. Starting a Club, International Racing Rules.

Price £3.25 (plus P & P 35p)

L-D EDITORIAL & TECHNICAL SERVICES LTD.
PO BOX 30 HEMEL HEMPSTEAD HP1 1NL

Or from good R/C Model Shops and Booksellers

SHOPPING AROUND

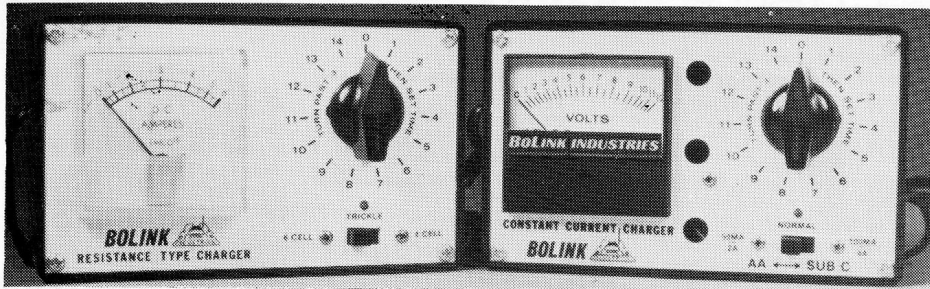

Two Bo-Link chargers — your choice Resistance type or Constant Current.

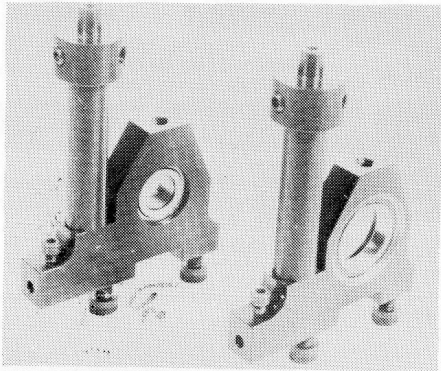

PBS black anodised plunger blocks incorporating wing and body fixings from Ted Longshaw.

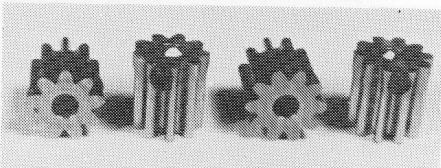

The nice little 9- and 10-teeth pinions from Leamington Hobby Centre. Note location of allen screw fixing.



Unitrol speed controller — a neat compact accessory being seen in increasing numbers at major meetings.

WITH the continuing spate of really top class open events for 1/12th electric cars I was delighted to learn that John Gosheron & Co were producing a special self-adhesive tape specially for marking out floors under the title of Floorline. (Gosherons incidentally have supplied my old group MAP with rolls of self adhesive address labels since almost before the stuff was invented!) It comes in rolls from 1in to 4ins. wide in either white or yellow. For marking out circuits yellow stands out terrifically on very nearly any surface. Info can be obtained from John Gosheron & Co Ltd tel: 01-937-8011 (Ask for David Burton) or single rolls from C & T Enterprises, 151 White Hart Lane, Porchester Fareham, Hants PO16 9AY. Though permanent enough for sports centre marking it can easily be removed when hall only temporarily booked — so no nasty remarks from the caretaker!

Now that race times are moving into the six and seven minute phase more and more attention is being paid to getting the most out of nicads with a resultant enlargement of charging apparatus. Bob Rule has sent details of his Constant Current Charger and his Resistance Type Charger. The former has trickle (slow) charge features to capacity match batteries for longer running time, for AA or Sub C Nicads; built-in 0-10 volt meter and gives exact charge in batteries at all times. The Resistance Charger provides fast or slow charge; 15 minute timer with amp meter and fits all Bo-Link cars and most others with adapter. Both chargers operate on 4 or 6-cell packs. Micro-Mold are main British suppliers though most good r/c model shops of course carry the Bo-Link line.

Still with electrics production model of the Unitrol Electronic Speed Control, pre-production models of which I was very impressed with at Bradford last year, are now available from Unicorn Electron-

ics, 11a Broomfield Road, Earlsdon Coventry. It features very fast response, with proportional forwards and reverse, 6-volt regulated output to radio and servos, output 14 amps (peak 25amps). It is conveniently small and light in weight and comes to you for £34. inc VAT.

Nick Adams well proven Demon speed controller is now available with reverse function and production is being stepped up, though as a handmade precision job cannot ever go into mass production. It is a recent addition to the range of Phil Greeno "goodies" making up the successful Gemini kit. Reference PGE-DM1 gets the standard Demon (forward only) £34.50 and PGE-DM2 the reverse version at £39.95.

Once more on 1/12th I have a further source of pinions in 9 and 10-tooth sizes to suit Mardave and Schumacher. These are precision machined in stainless steel with allen screws in the body of the gear. Leamington Hobby Centre of 112 & 129 Regent Street, Leamington Spa, who claim to have been first in the market with them are selling them at £1.45 each.

Start of the outdoor season for 1/8th was heralded in at Easter with the meeting at Bournemouth's Tubary Park Circuit to show at least a glimpse of what may be in big demand during the months ahead. The strong PB team were using the fascinating "tweakers" on the front of their GRP chassis. A simple little flat V for Victory plate it can work wonders on the front end trim by tightening or loosening the retaining screws. This makes up for the extreme rigidity of GRP as against metal which can be twisted (in a continuing and unwelcome way sometimes!) With the "tweaker" precise adjustment can be made and **retained**. I first saw these in use last year in Geneva, now most of the expert drivers are fitting them.

Not on the market yet, but undergoing their last preproduction trials are the suspension units, front and back, just revealed by AMPS who of course produced their revolutionary diffs for the first Monaco Cup two years ago. These look very promising and are designed to take an inline engine mounting fitted to virtually any of the popular kits. You can start with a rear end fitting only and add the front end later or go for the lot straight-away. They obviously will show to the best effect on a really bumpy circuit. I am not going to be a beast and suggest where their use will be most valued. AMPS by the way are now handling Parma bodysells in addition to Ted Longshaw who tells me he has virtually the whole range, and if

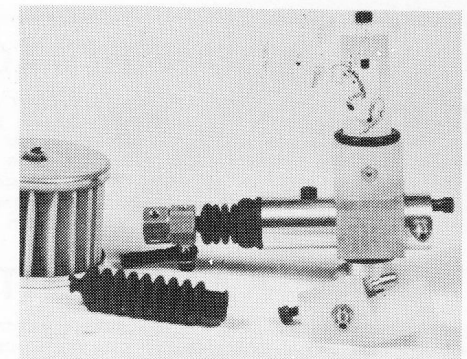

Preston slide carb which Dave is selling at meetings to go with the PBS goodies, or from Ted Longshaw, Jim Davis. etc.

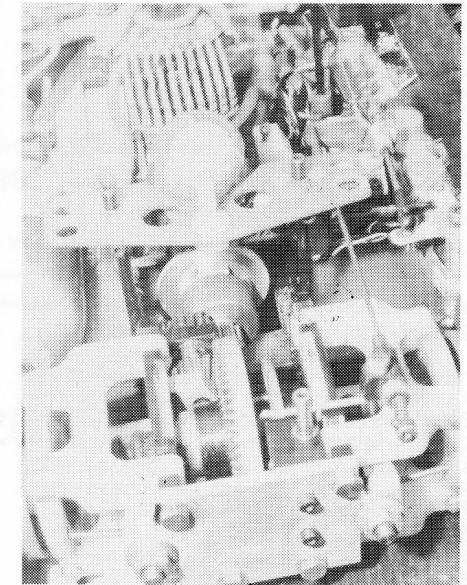

Another shot of our cover picture showing the latest AMPS sprung suspension. This is still prototype but soon I believe to be on the market.

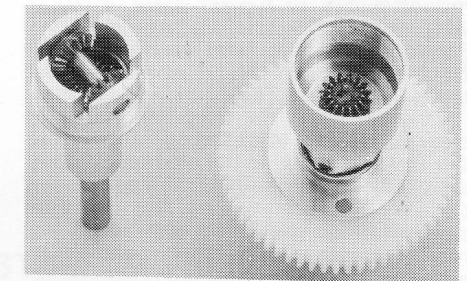

Fascinating 1/8th scale diff from Graupner — a beautiful engineering job for their cards and presumably adaptable to others.

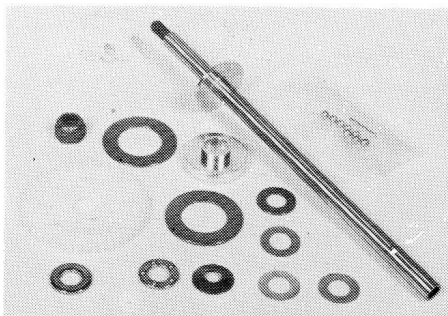

Associated 1/12th diff which is supplied as a kit with assembly instructions to fit RC12E.

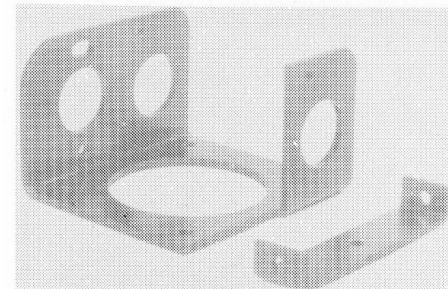

Leisure alloy rear end which should appeal to scratch-builders.

you have any unusual requirements can get them in within a couple of weeks.

I am ashamed to note that though I have mentioned them in general I have not yet illustrated any of the PBS parts that Phil Booth and Dave Preston are masterminding. These are designed as specially precision machined parts to fit on the PB9 International. They are not cheap and frankly they won't enable an average driver to reach the top in one mighty stride. They are strictly for the man already getting all he possibly can out of his car and seeks that more than a 100% performance. I show the combined rear plunger blocks, ballraced and wing mount pillars as typical parts. Another very worth while addition would be the Preston slide carb with secondary fuel adjuster. There are over a score of special parts all shown in Ted's catalogue at 75p.

I cannot resist the very beautiful and clear photo that I got from Graupners at the Toy Fair showing the elegant diff they are providing for their latest expert speed car. By now some of the Nuremberg offerings should be coming on the market together with other manufacturers' specials eagerly awaited... I am thinking specially of items like this and Tamiya's sidecar outfit (with organisers

waiting to run extra events for them!)

The Toy Fair reminds me of my sackcloth and ashes of the month. Keith Plested PA Paul Pagdin reminds me in brusque Yorkshire fashion that I did less than justice to the new Colt (PB10) selling at £45.95. This does have the tank included and the clutch is the same standard job that goes with the other PB kits. Sorry Keith! But I did get the name right! Colt! Gee-gee or Bang-bang the name means Go-go in virtually any language!

In addition to their amazing range of bodyshells in both 1/12th and 1/8th scales clear or painted, Parma are branching out in some very useful accessories for the electric market. Such useful items as plunger blocks and kingpost mountings in tough nylon, body retaining clips, chassis plates, resistor wiper arms and decal sets. A recent attractive body is that of the Mirage M-10 as raced at Le Mans. Parma are also part of the consortium responsible for the Group 12 Car which should shortly be making its impact on the British racing scene.

It is a happy co-incidence that along with my MRP kit reviewed in this issue I have a new firm adorning our advertisement columns One-O-One of Gillingham who are in fact able to produce MRP bits and pieces at short notice or from stock. They also handle very nearly every other American company, particularly those with continuing slot-car connections since, until now, that has been their main concern as specialist slotcar people. Dave Harvey and Garry King the proprietors have produced a useful little catalogue and understand the "bits and pieces" market of the scratch builder to a T. Garry has provided to my first sight of the Associated diff. for 1/12th which naturally fit the RC12E without having to change wheels, present price is £9.45. A similar diff. from Leisure has the virtue that it fits any 1/2" dia. axle but sells at £12.45. Also from Leisure is their very useful alloy rear end in a black anodised finish.

Long experience of painting bodyshells for 1/24th scale cars has given them a useful delicate touch for the larger sizes - so if you fancy a very special paint job get in touch. Naturally a smallish firm cannot carry an immense stock, but friendly personal relations, and regular air mail deliveries keep any waiting down to two or three weeks, and with a specialist market in mind they have opened up business with a number of similar firms in U.S.A. who do a small but high quality precision class of work.

WE'VE GOT THE PARTS

One-O-One specialise in selling only the best 1/12 electric parts and cars. You won't find any "toys" on our list. What you will find are parts by Parma, Trinity, Associated, Greeno, Mura, Leisure and more. Some of the names you won't have heard of, but the quality and performance are high.

Some examples from our list. Leisure 2002 alloy rear axle/motor mount **£4.95**. Trinity silicon lead wire, hundreds of strands plus its heatproof **55p**. Associated complete front end pack (steering) **£4.95**. Stock 05 motor **£5.95**. Pinnion puller **£2.50**. Parma soft rear tyres **£1.90**. Carbon fibre chassis blanks, stronger and lighter than GRP **£11.95**. Parma, Reedy, and One-O-One motors from **£15.95 to £33.95**. Plus much more.

WE'VE GOT THE KNOW HOW

One-O-One are the UK's leading specialist DC motor builder, we have over 14 years experience, during which time our parts and services have helped people win no less than 2 European and 5 National Championships. We have competed in British, European and World Slot Racing Championships, gaining valuable knowledge and experience which we pass on to our customers in the form of advice and improved parts and services. We selected the 05 motor Phil Greeno used in the Standard Final at Birmingham Bingley Hall. Well done Phil.

WE CAN REBUILD

One-O-One can true your comm's, re-zap your magnets, glue and true your tyres, spray your bodies, tune your motor, even build you a complete car, but above all we can offer you the parts and advice to improve your cars performance.

Now you know the name, do yourself a favour and send a SAE for our list.

ONE-O-ONE R/C, 52 HAWBECK RD., PARKWOOD, RAINHAM, KENT

MEDWAY 364823 EVENINGS ONLY

ACCESS BARCLAYCARD

MAIL ORDER ONLY. TRADE ENQUIRIES WELCOME.

LEAMINGTON HOBBY CENTRE

0926 29211

**NOW IN STOCK
LECTRICAR STOCK CAR**

£59.95

**NEW! FUTABA!
2 Channel Combo's
£12.00**

**Servo's - £11.00
mid-May, order now**

**Mardave Mk 2 Elec. £42.50
Lectricar Kit £49.95
Plus all spares**

**112 and 129 REGENT STREET, LEAMINGTON SPA
WARWICKS**

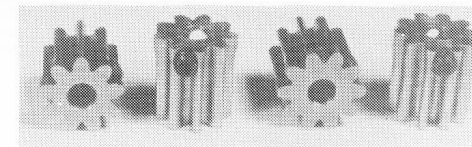

9 and 10 tooth Pinions to suit Mardave and Schumacher, precision machined from stainless steel **£1.45 EACH**

High Performance Motors available **£20.50**

**TRADE ENQUIRIES
WELCOME**

MARDAVE - VECO SPARES



Good stock of 1/8 Stockcar,
Autocross, and Veco Engine
Spares Plus Kits of course

Other Makes of Engines and
Electric Car Kits inc. Aircraft
and Boats

BALLARD'S

108 CAMDEN ROAD,
TUNBRIDGE WELLS,
KENT. TN1 2QX.
Phone 0892-31803

MICHAEL'S MODELS

646-648 High Road,
N. Finchley, N12 0NL
Telephone: 01-445-6531

ELECTRIC KITS

Mardave 1/12	£42.95
Lectricar Stockcar 1/12	£59.95
Tamiya 'Rough Rider'	Buggy £69.99
Graupner Motorcycle	£47.95

RACING 1/8 KITS

PB 9 International	£127.27
PB 6 International	£79.88
PB 10 Colt	£45.95
Associated RC100	£69.95
Mardave Stockcar	£26.50
Mardave Comp Racing Car	£29.80
Yu-Can Stockcar	£32.95

Full range of Spares — Engines —
Bodies

Send S.A.E. for complete car list

MANUFACTURERS

Special Parts Makers

Established agent for local
engineering companies, has an
opening for further business in
obtaining machining facilities for
the production of components in
large or small quantities

Contact:

DAVE GIBSON,

7-11, Villa Street, Beeston,
Nottingham.

Tel: Nottingham 284799 or
Nottingham 257925

PLANS

of 1/8th Scale Radio Control Model Cars

These are fully dimensioned engineering
drawings for the metal working model
maker, detailing almost 100 parts in each
car.

STOCK CAR PLANS — £5 A SET

Coil spring suspension, independent
front and trailing arm rear.

FORMULA ONE PLANS — £6 A SET

Unique chassis, Hydraulic disc braking.
Independent front suspension.

Both designs conform to current con-
struction rules and are fully featured in
the "Radio Control Model Cars Manual."

Excellent Club, School or Unimat 3 pro-
ject. Many sold. U.K. post paid. Overseas
welcome

HOBBS MODEL CARS

27 HOLCON COURT,
REDHILL, SURREY
Tel. 62190

WHAT A BIND!



Sent direct
by
Easibind
Allow 2/3
weeks for
delivery

Elegant BINDERS to take twelve copies (two year run)
of RADIO CONTROL MODEL CARS now ready. Covered
in Red Balacron (a leather-like material) with "gold"
colour title blocked on spine they have the famous
Easibind system of holding copies without damage
and permitting easy removal. Price includes postage,
packing and VAT.

VERY SPECIAL OFFER

~~£3.25~~
£2.25

HOME

~~£3.75~~
£2.75

OVERSEAS

L-D Editorial & Technical Services Ltd

PO Box 30 Hemel Hempstead, Herts.

STRENGTHENED REAR-END BLOCK AND AXLE ASSEMBLY --- FOR GRAUPNER 1/12th F.W.D. CARS

AS RECOMMENDED FOR 'SERIOUS
RACERS IN THIS MAGAZINE -
LAST ISSUE (GRAUPNER FWD CAR
REVIEW)

AS USED AT FIRST SCOTTISH
GRAND PRIX - 2nd SENIOR EVENT,
1st JUNIOR EVENT and SET FASTEST
OVER ALL TIME

ALUMINIUM BLOCK - STAINLESS
STEEL AXLE - PTFE BEARINGS

COMPLETE ASSEMBLY £15.50
incl. p. & p.

FITS DIRECTLY ONTO CHASSIS
WALKER RACING
84 FORREST WALK, UPHALL,
WEST LOTHIAN, EH52 5PW

THE MODEL AIR-PORT

FILTON

BRISTOL

R/C CARS
ENGINES
RADIO

MAIL ORDER
ACCESS
BARCLAYCARD
HOBBYCARD

EXIT 16 - M5 Five Minutes
Closed Wednesday

134 GLOUCESTER ROAD NORTH
FILTON, BRISTOL. TEL: 694541



P.B. SLASH PRICES!

As a result of increased efficiency and despite raging inflation we have been able to reduce the retail price of approx. 50% of our products.

START

PB LEADS THE FIELD FROM

TO

FINISH

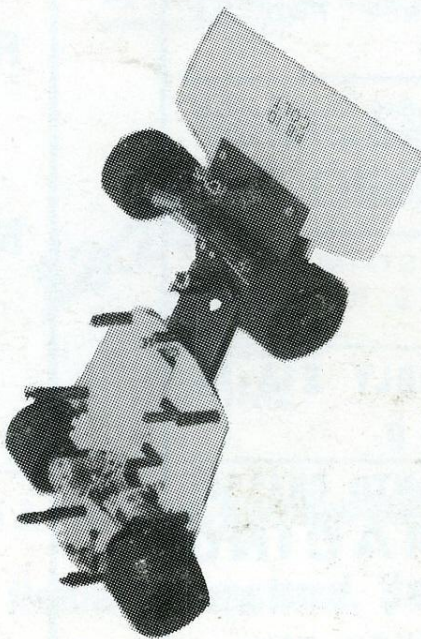

£45.95 INC. VAT

AND WE CAN HELP YOU
ALONG THE WAY TO
UPDATE YOUR CAR IN
STAGES USING OUR
TUNING AIDS,
UPGRADED PRODUCTS
AND ACCESSORIES



£127.27 INC. VAT

WORLD CHAMPIONS 1978 & 1979

**PB RACING PRODUCTS LTD., DOWNLEY ROAD, HAVANT, HANTS.
TEL. (0705) 471774**